

www.duseko.com

Ürün Katalođu
Product Catalogue



 **DSKLIFT**[®]
bir  **DUSEKO**[®] markasıdır.
ASANSÖR İNŞ. MAK. SAN. VE TİC. LTD. ŞTİ.

 **DUSEKO**[®]
ASANSÖR İNŞ. MAK. SAN. ve TİC. LTD. ŞTİ.



AZ ye
TÜM ASANSÖR
EKİPMANLARI

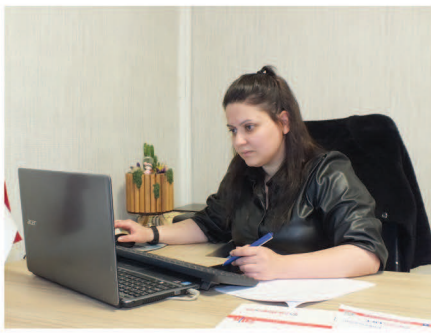



**SEKTÖRÜN
LİDERİ**

**3 KITA..
22 ÜLKE**
ihracat

Hakkımızda

DSKLİFT bir DUSEKO® markasıdır.
ASANSÖR İNŞ. MAK. BAK. VE TİC. LTD. ŞTİ.

Duseko Asansör, sektörde lider ve başarılı malzeme üreticilerinden biri olarak müşterilerine güvenli ve kaliteli asansör komponentleri hizmetleri sunmaktadır. Şirket, 2006 yılından itibaren olan deneyimi ile 2015 yılında şirketleşmiş olup Türkiye ve dünyada satışa başlamış ve müşteri memnuniyetini her zaman öncelikli hedef olarak benimsemiştir. Türkiye'de asansör sektörüne artı değer katmak amacıyla faaliyetlerini ileri seviyeye taşıma gayesi gütmektedir.

Gelişim ve ilerlemenin gerekli ilkesi olarak Duseko Asansör 4000 m² kapalı alan içerisinde sürekli yatırımlarını artırarak ve imalat parkurunu genişleterek, teknolojik makinalarla donatarak müşterilerine daha kaliteli ve seçkin ürünler üretmektedir. Geniş ürün yelpazesini seçkin malzemelerden oluşturan Duseko Asansör bu sayede güvenli, pratik ve kesintisiz hizmet vermeyi kendisine ilke edinmiş, müşterilerini anlayıp proje bazlı ve teknolojik çözümlerle yanında olmayı kendine misyon edinmiştir.

Duseko Asansör hayata, insana olan değeri ve girişimci ruhu ile müşterileri, tedarikçileri, profesyonel ve gayretli ekibi ile ben değil biz olma bilincini taşıyarak çalışmalarıyla ülkemizde ve çok farklı ülkelerde isminden sıkça bahsedilen bir marka haline gelmiştir.

Duseko Asansör, dünya standartlarına uygun ürünleri ve hizmetleriyle fark yaratmaktadır. Ürünlerini TSE ve Avrupa standartlarına uygun üretmektedir. Yüksek kaliteli ürünleri ve güvenilir hizmetleri sayesinde, müşterilerinin ihtiyaçlarını doğru tespit ederek, onlara en iyi hizmeti sunan Duseko Asansör, sektörde marka değeri yaratan bir firmadır.

Şirket nitelikli insan kaynağı, güçlü üretim tesisi, yeniliğe açık yapısı ve çözüm odaklı yaklaşımı ile satış ve satış sonrası hizmeti ile müşterisinin her daim yanındadır

Amacımız kazandığımız başarı ve güven ivmesini daha da yukarı taşımaktır.

Saygularımızla...

Markamızın Yüksek Başarısı...

 Komple paket malzeme satışıımız vardır.
We have a complete package of material sales.

About Us

Duseko elevator, as one of the leading and successful material manufacturers in the elevator industry, provides safe and quality elevator components service to its customers. With its experience since 2006, the company has become a company in 2015 and started sales in turkey and the world, and has always approved customer satisfaction as a priority target.takes its activities to the advanced level in order to add additional value to the elevator industry in Turkey.

As a required principle of development and progress, duseko elevator is producing more quality and exceptional products to its customers, by increasing its continuous investments in 4000 mt2 closed area and equipping its manufacturing park with technological machines. Consisting its wide product range of electric materials, duseko elevator has been its principle to provide safe, practical and uninterrupted services.

Duseko elevator has become a brand that is frequently mentioned in our country and in many different countries with its customers, suppliers, professional and diligent team with its value and entrepreneurial spirit to life and humanity.

Duseko elevator makes a difference with its world standards and services. Manufactures its products according to tse and european standards. Thanks to its high quality products and reliable services, duseko elevator is a company that creates a brand value in its industry, detecting its customers' needs correctly and offering the best services to them." the company is always side of its customer with qualified human resources, strong production facility, innovative structure and solution-oriented approach and sales and after sales service. Our goal is to carry the momentary of success and confidence further.

Best Regards...

معلومات عنا

دوسيكو للمصاعد, باعتبارها واحدة من مصنعي المصاعد الراندين والناجحين في صناعة المصاعد ، خدمة مكونات المصاعد الآمنة والجودة لعمالها. من خلال الخبرة التي اكتسبتها منذ عام 2006 ، تم تأسيس الشركة في عام 2015 وبدأت مبيعاتها في تركيا والعالم ، وتسعى دائماً لرضا العملاء كهدف أساسي لها. تأخذ أنشطتها إلى المستوى المتقدم من أجل إضافة قيمة إضافية إلى صناعة المصاعد في تركيا. كمبدأ ضروري للتطور والتقدم ، تعمل دوسيكو للمصاعد على زيادة استثماراتها باستمرار في مساحة 4000 متر مربع داخلية وتجهيز مسار التصنيع بالآلات تقنية ، مما يجعل منتجاتها عالية الجودة. دوسيكو للمصاعد, الذي تصنع مجموعة واسعة من المنتجات الخاصة بها. من مبادئها تقديم خدمة عملية وغير منقطعة ولديها فريق لفهم عملائها وأن تكون جنباً إلى جنب مع الحلول المستندة إلى المشاريع والتكنولوجيا. دوسيكو للمصاعد بفضل فريقها المحترف أصبحت علامة تجارية في تركيا والعديد من البلدان المختلفة. للمصاعد بتصنيع منتجاتها وفقاً لمعايير TSE. تقوم شركة دوسيكو العالمية والمعايير الأوروبية وبفضل منتجاتها عالية الجودة وخدماتها الموثوقة, استطاعت تحديد احتياجات العملاء بشكل صحيح وتقديم أفضل الخدمات لهم. دوسيكو للمصاعد تقوم بتأمين خدماتها ما بعد البيع على اكمل وجه . هدفنا هو الارتقاء بمستوى النجاح والثقة الذي حققناه الى مستويات اكبر .

يعتبر...

Kalitenin Güvenilir Adresi...
Reliable Address of Quality...
عنوان موثوق للجودة...

شهادات | Certificates | Sertifikalar







*Tavan
Seçenekleri*

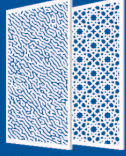

*Kaplama
Seçenekleri*



*Taban
Seçenekleri*



➤ DSK-250

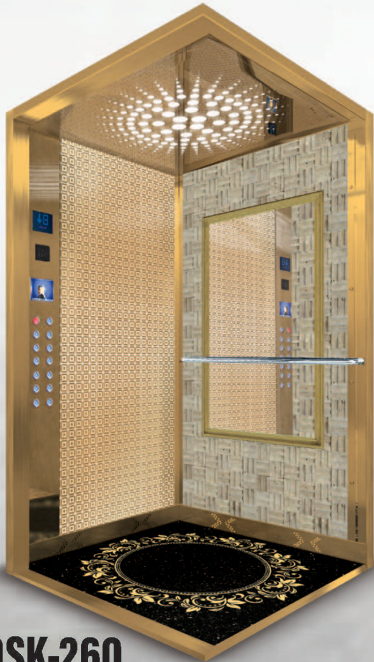

➤ DSK-260



➤ DSK-270



➤ DSK-280



Tavan Seçenekleri

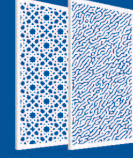

Kaplama Seçenekleri



Taban Seçenekleri

DSK-290



> DSK-300



> DSK-310



> DSK-320



*Tavan
Seçenekleri*

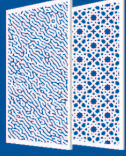

*Kaplama
Seçenekleri*



*Taban
Seçenekleri*



➤ DSK-330



➤ DSK-340



➤ DSK-350



➤ DSK-360



*Taban
Seçenekleri*

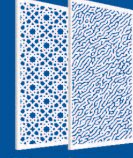

*Kaplama
Seçenekleri*



*Tavan
Seçenekleri*

DSK-370



> **DSK-380**



> **DSK-390**



> **DSK-400**



*Tavan
Seçenekleri*

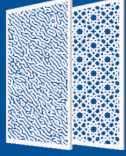

*Kaplama
Seçenekleri*



*Taban
Seçenekleri*



➤ DSK-410



➤ DSK-420



➤ DSK-430



➤ DSK-440

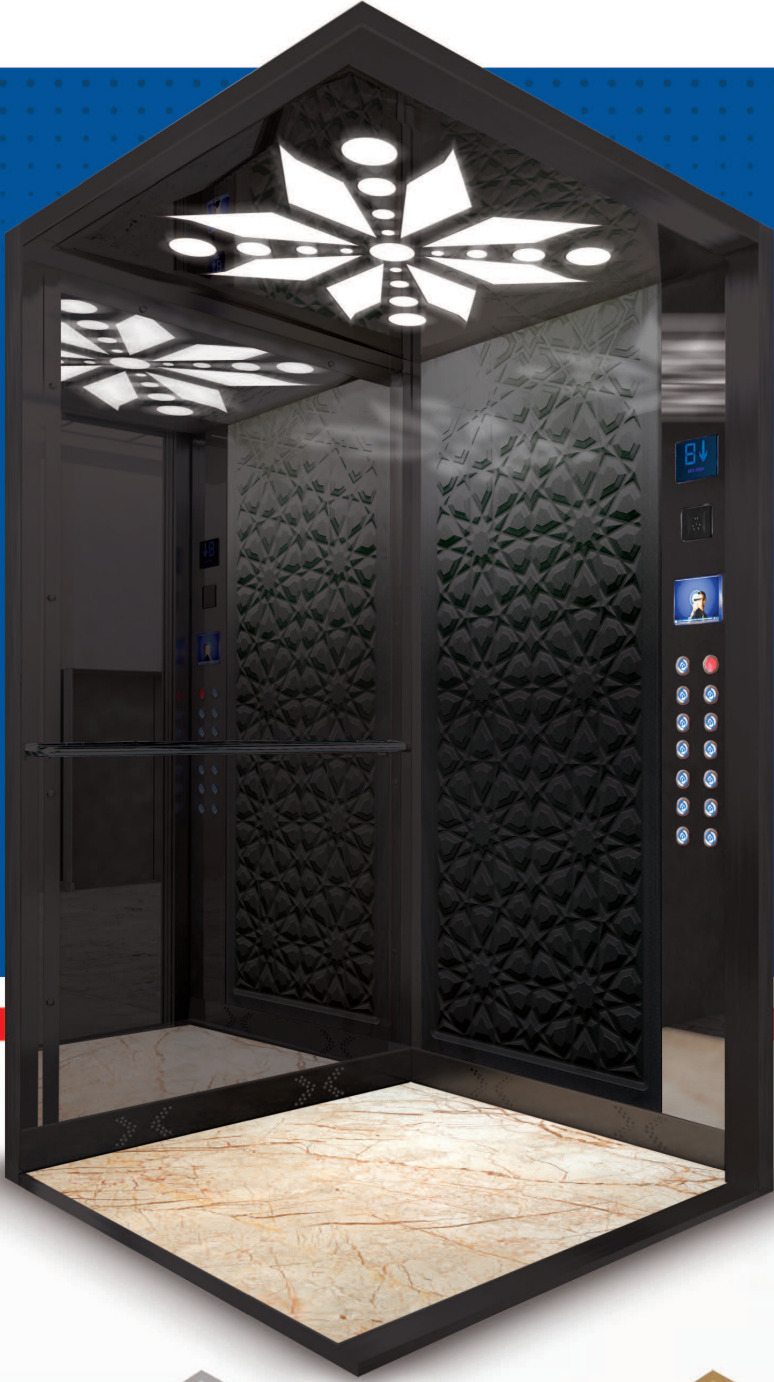

Tavan Seçenekleri

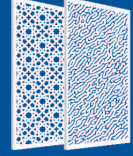

Kaplama Seçenekleri



Taban Seçenekleri

DSK-450



> **DSK-460**



> **DSK-470**



> **DSK-480**



*Tavan
Seçenekleri*

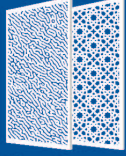

*Kaplama
Seçenekleri*



*Taban
Seçenekleri*



➤ DSK-490



➤ DSK-500



➤ DSK-510



➤ DSK-520



Taban
Seçenekleri

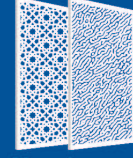

Kaplama
Seçenekleri



Tavan
Seçenekleri

DSK-530



➤ **DSK-540**

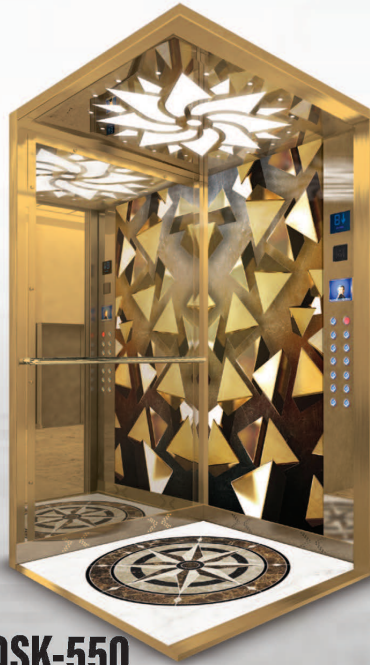

➤ **DSK-550**



➤ **DSK-560**



*Tavan
Seçenekleri*

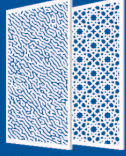

*Kaplama
Seçenekleri*



*Taban
Seçenekleri*

➤ DSK-570

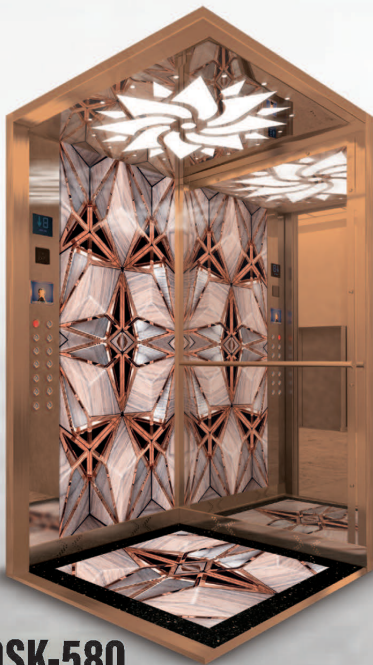
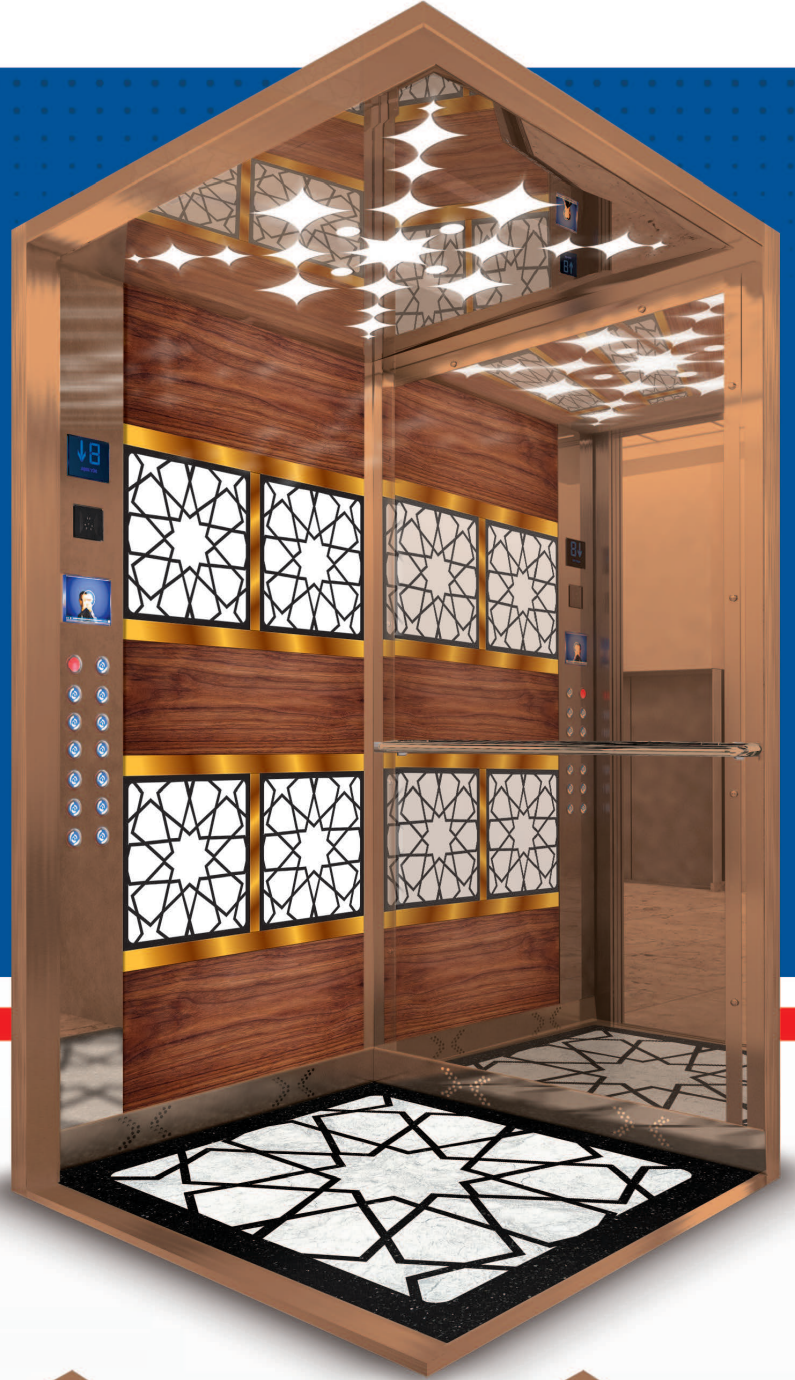

➤ DSK-580



➤ DSK-590



➤ DSK-600



Tavan Seçenekleri

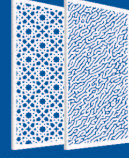

Kaplama Seçenekleri



Taban Seçenekleri

DSK-610



> **DSK-620**



> **DSK-630**



> **DSK-640**



*Tavan
Seçenekleri*

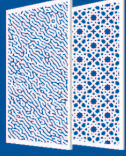

*Kaplama
Seçenekleri*



*Taban
Seçenekleri*



➤ DSK-650



➤ DSK-660



➤ DSK-670



➤ DSK-680

Engelli Platformu

Disabled Platform | منصة المعوقين

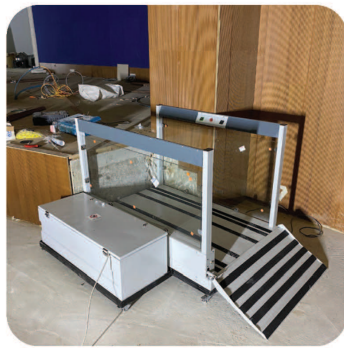

ÖZELLİKLER

- 1,5 mm sac
- Satine paslanmaz yan duvarlar
- Lazer tavan
- Kolay takılabilir küpeşte
- Aydınlatma ve havalandırma bağlantıları
- Alüminyum çeta taban
- Farklı taban seçenekleri
- Tercihe bağlı sandık ambalaj
- Titreşimi önleyen özel bükümler ve takozlar

FEATURES

- 1.5 mm iron sheet
- Satine stainless side walls
- Laser ceiling
- Easily installed rail
- Lighting and ventilation connections
- Aluminium knurled ceta base
- Different base options
- Optional packing crate
- Special bends and dampers that prevent vibration

الميزات

- 1,5 mm المجلفن الجدران الجانبية الساتنية
- سقف الليزر
- درابزين
- الإضاءة والتهوية
- أرضية الألومنيوم
- خيارات الأرضيات
- عند الطلب صندوق
- الانحناءات الخاصة والمخمدات التي تمنع الاهتزاز



Panoromik Kabin

Panoramic Cabin | كابينة بانورامية



ÖZELLİKLER

- 1,2 mm sac kabin duvarları
- Paslanmaz çelik
- Hem iç hem dış paslanmaz kaplama
- Tamamı lazer kesimli parçalar
- Üç cepeye kadar cam seçeneği
- Farklı taban ve tavan seçenekleri
- Oval cam seçeneği
- Lamine cam koruma sertifikalı

FEATURES

- 1,2 mm sheet metal cabin wall
- Quality stainless steel
- Both internal and external stainless coating
- All parts are laser cut
- Glass options up to three sides
- Different floor and ceiling options
- Oval glass option
- Lamine glass -certification

المميزات

- 1.2 مم جدران خزانة من الصفائح المعدنية
- من الفولاذ المقاوم للصدأ
- طلاء داخلي وخارجي غير قابل للصدأ
- جميع قطع الليزر
- خيار زجاجي مع ما يصل إلى ثلاثة جيوب
- خيارات مختلفة للأرضية والسقف
- خيار الزجاج البيضاوي
- شهادة حماية الزجاج الرقائقي





Aksesuarlar
Accessories

Dekoratif Paslanmaz

Decostyle Stainles | الستانلس المزخرف



DG-03

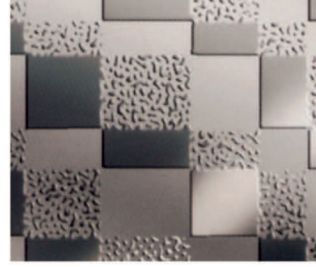

DM-17



DM-10



DM-01

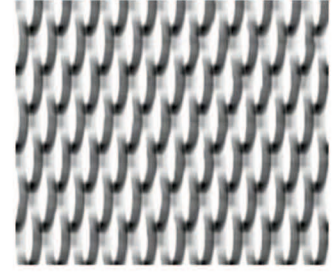

5-WL

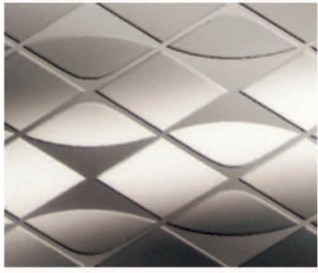

DM-15

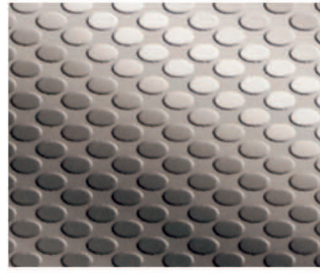

DM-09

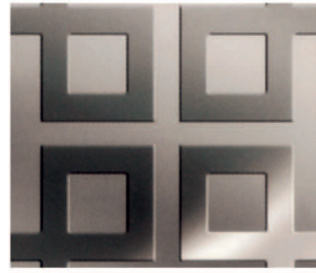

DM-21

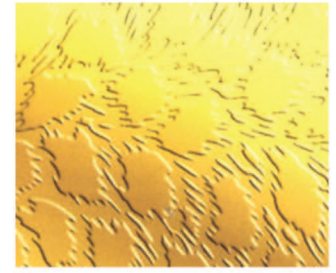

DG-25



DM-02



DG-10

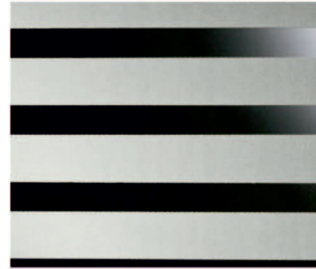

DM-24

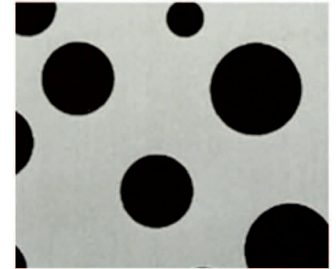

E-58

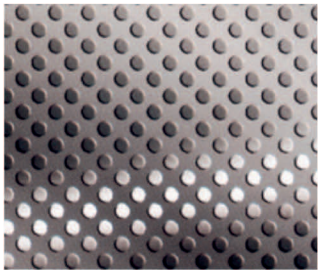

DM-09

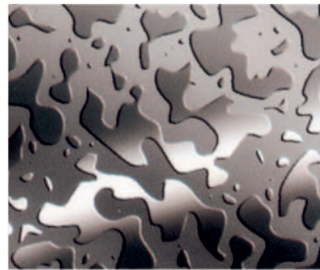

DM-05

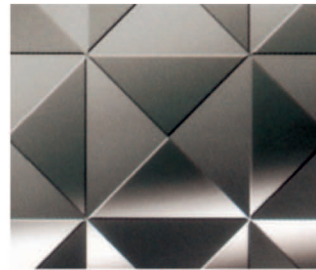

DM-13

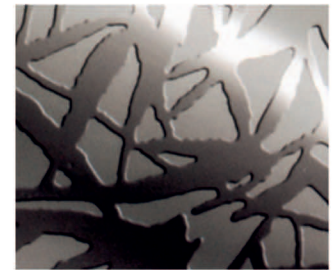

DM-04



DG NOKTA



DG-05



DG-02



DG-06

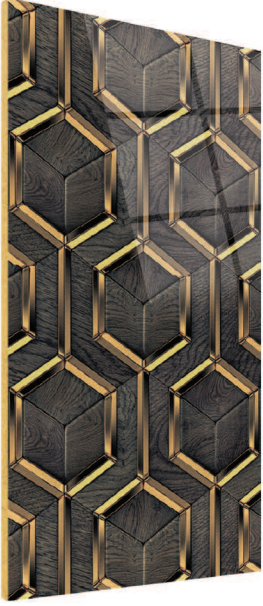

DCM-10



DCM-20



DCM-30

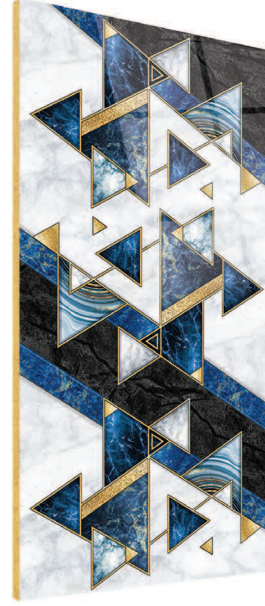

DCM-40



DCM-50



DCM-60



DCM-70



DCM-80



DCM-90



DCM-100



DCM-110



DCM-120

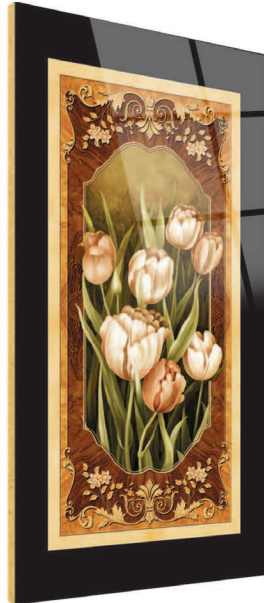

DCM-130



DCM-140



DCM-150

Cam ve MDF Kaplama

Glass and MDF Coated | زجاج و MDF مغطى

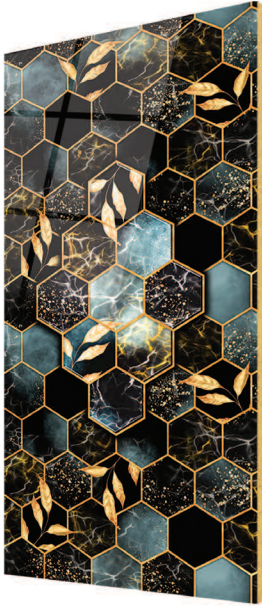

DCM-160



DCM-170



DCM-180



DCM-190



DCM-200

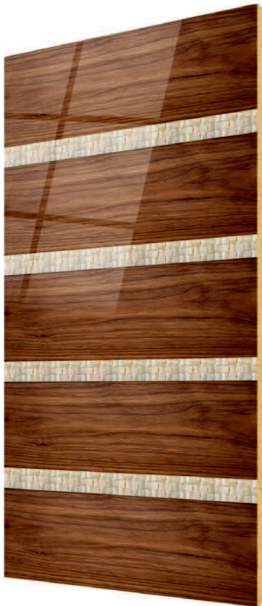

DCM-210



DCM-220



DCM-230

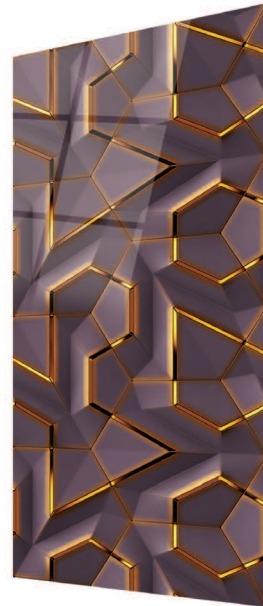

DCM-240

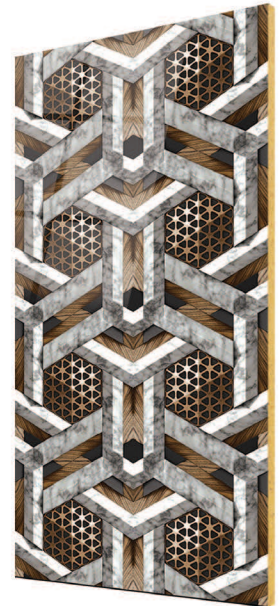

DCM-250

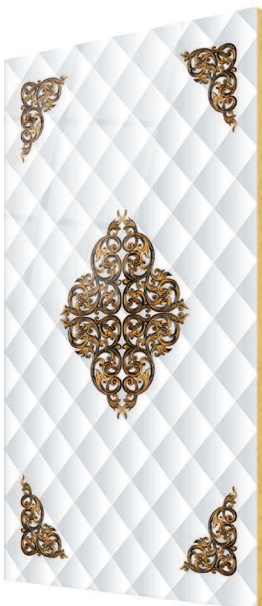

DCM-260



DCM-270



DCM-280

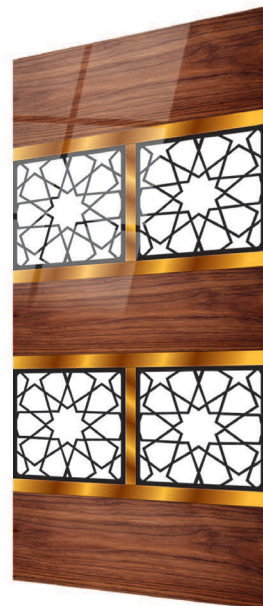

DCM-290

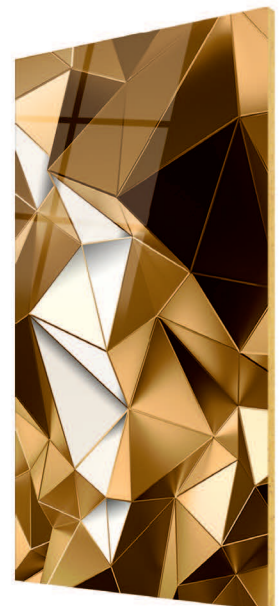

DCM-300



DCM-310



DCM-320



DCM-330



DCM-340



DCM-350

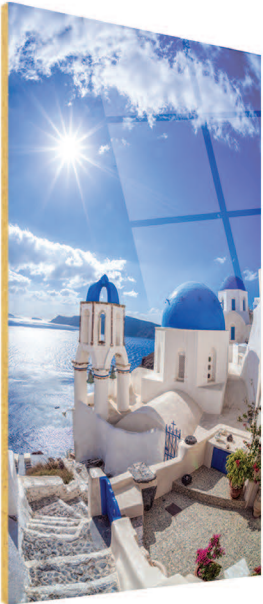

DCM-360



DCM-370



DCM-380



DCM-390



DCM-400



DCM-410



DCM-420

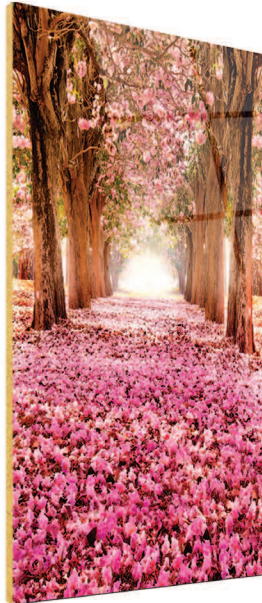

DCM-430



DCM-440



DCM-450

Cam ve MDF Kaplama

Glass and MDF Coated | زجاج و MDF مغطى



DCM-460



DCM-470



DCM-480



DCM-490



DCM-500



DCM-510



DCM-520



DCM-530



DCM-540



DCM-550



DCM-560



DCM-570

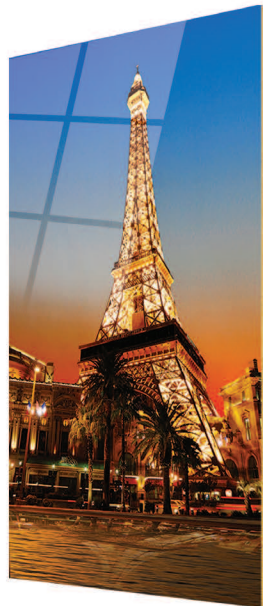

DCM-580



DCM-590



DCM-600

Cam | Glass | صنوبر



DTB-10



DTB-20



DTB-30



DTB-40

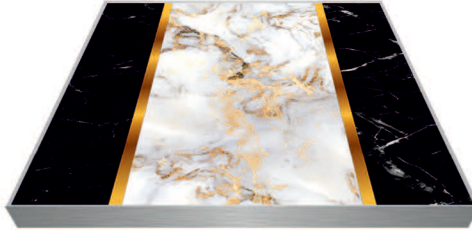

DTB-50



DTB-60



DTB-70



DTB-80

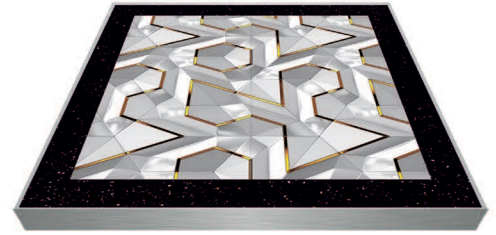

DTB-90



DTB-100

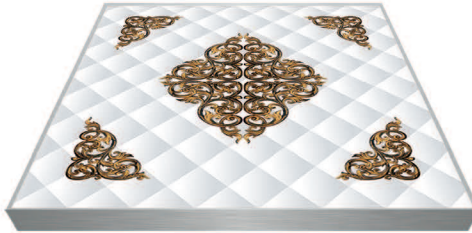

DTB-110



DTB-120



DTB-130



DTB-140



DTB-150

Özel Seramik Taban Seçenekleri | Special Ceramic Floor Options | أرضية سيراميك خاصة



BASRA ALTIN



CASBLANCA ALTIN



LUSAKA ALTIN

PVC | PVC | PVC



DTB-160



DTB-170



DTB-180



AEZ-149



AEZ-150



AEZ-152



AEZ-153



AEZ-157

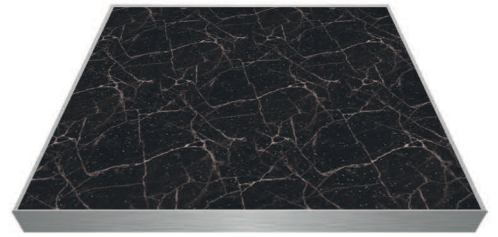

AEZ-211



AEZ-151

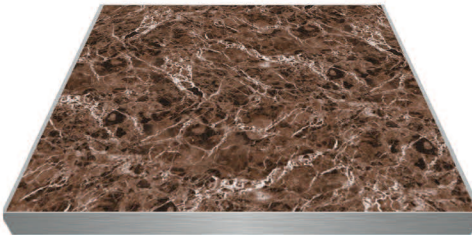

AEZ-210



AEZ-156

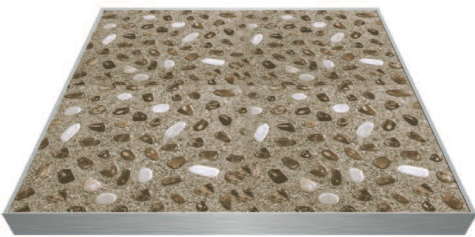

PVC-ES-5

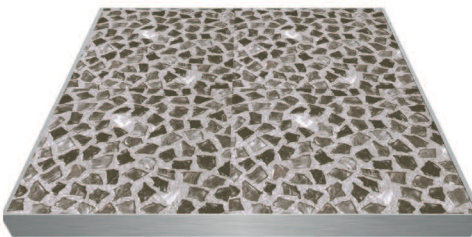

PVC-3714

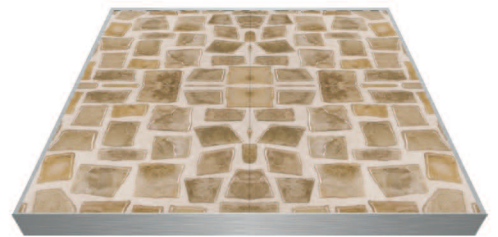

PVC-1341

Granit | Granite | جرانيت



ROSA PORINHO



STAR GALAXY



AKSARAY YAYLAK

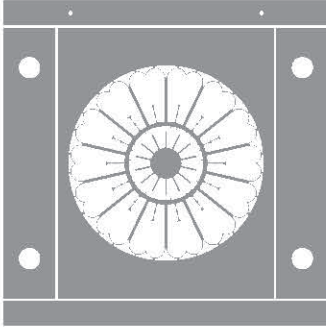

DTV-10

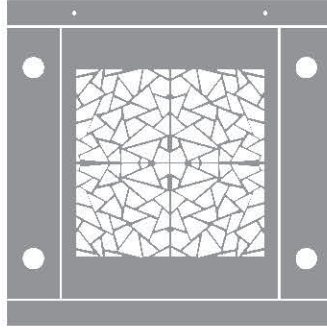

DTV-20

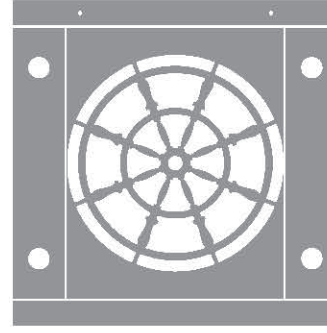

DTV-30

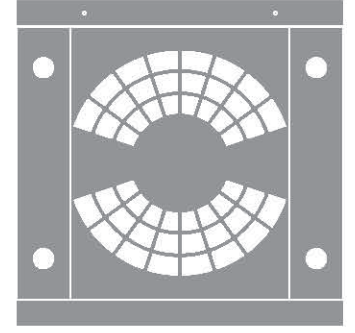

DTV-40

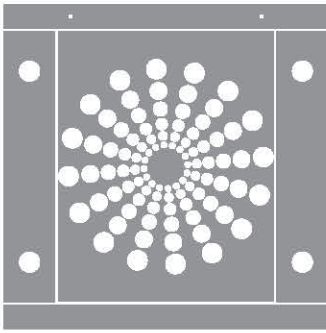

DTV-50

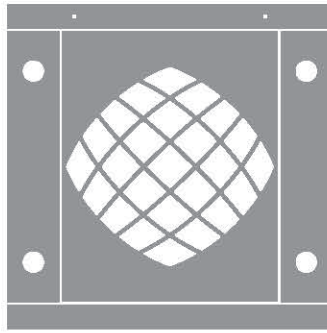

DTV-60

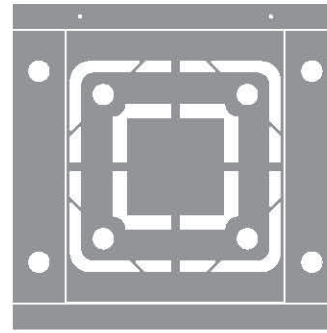

DTV-70

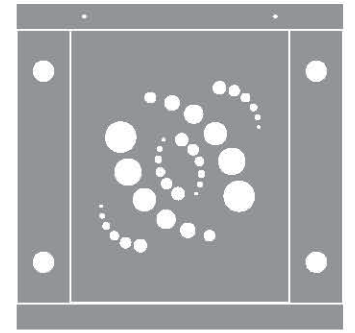

DTV-80

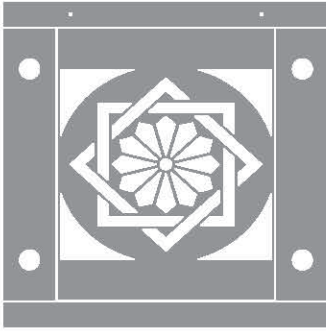

DTV-90

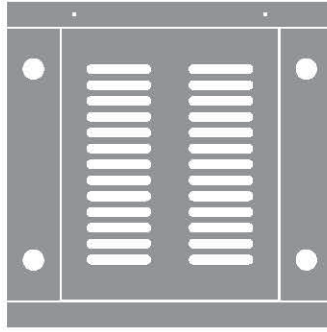

DTV-100

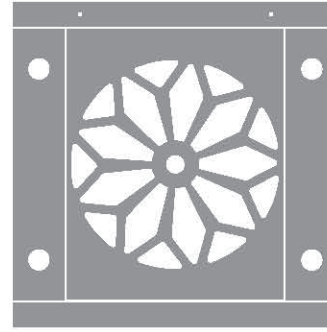

DTV-110

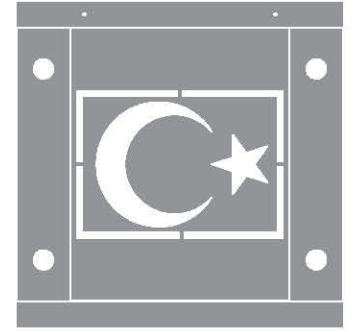

DTV-120

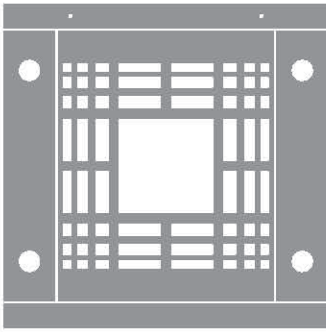

DTV-130

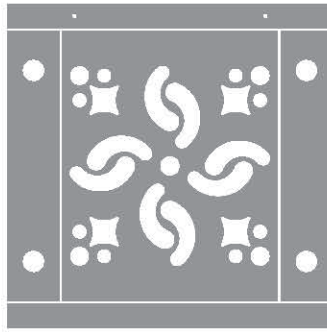

DTV-140

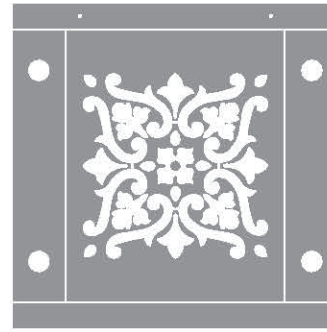

DTV-150

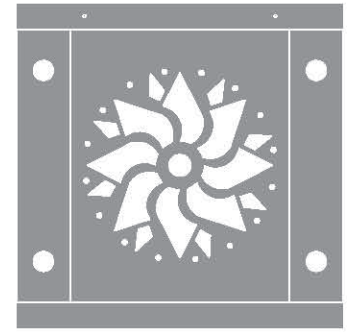

DTV-160

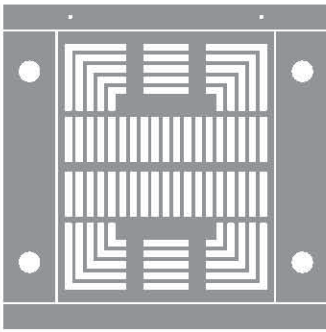

DTV-170

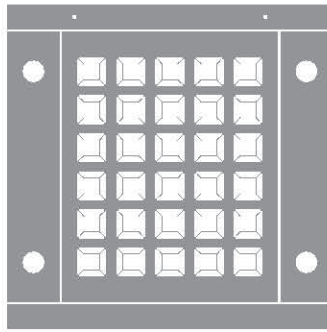

DTV-180

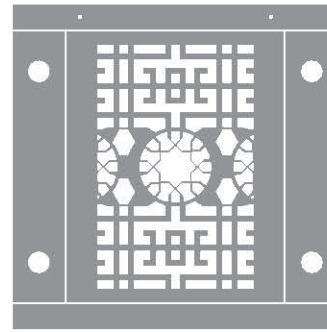

DTV-190

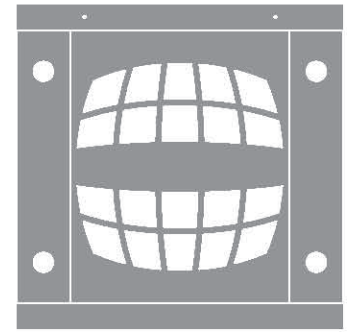

DTV-200

Tavan Seçenekleri

Ceiling Options | خيارات السقف

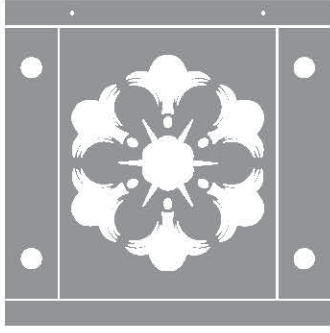

DTV-210

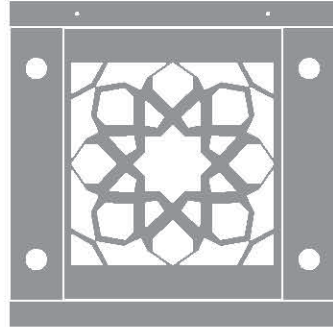

DTV-220

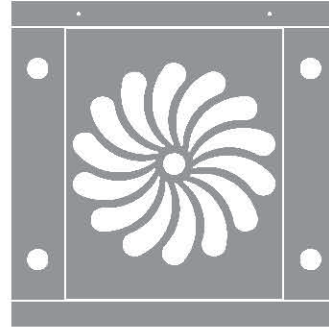

DTV-230

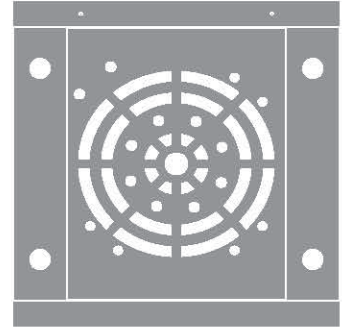

DTV-240

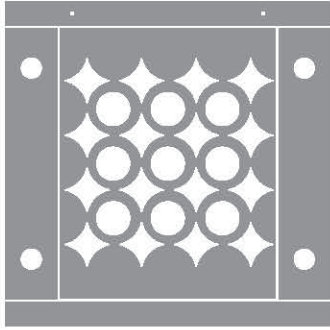

DTV-250

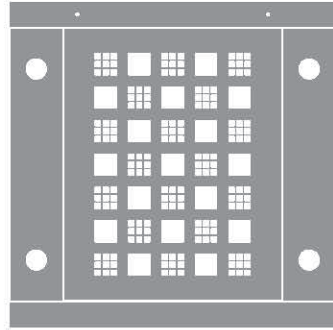

DTV-260

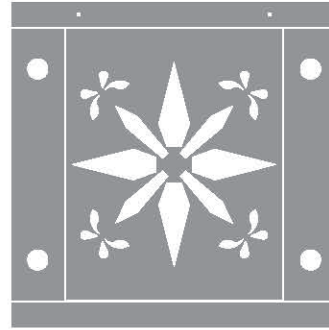

DTV-270

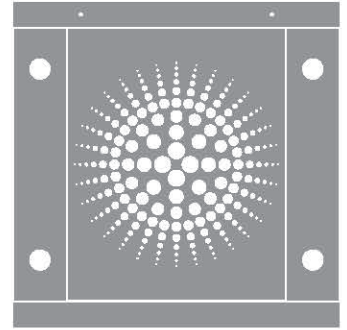

DTV-280



DTV-290

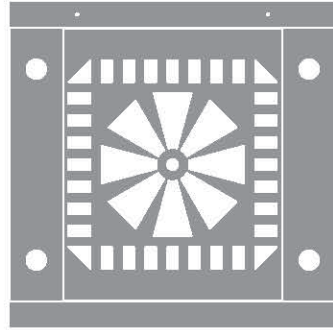

DTV-300



DTV-310

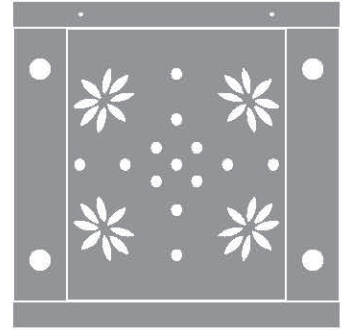

DTV-320

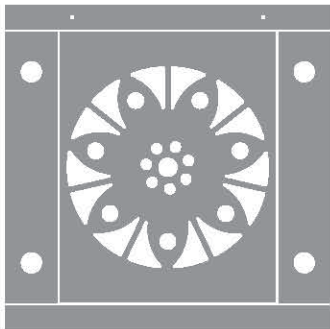

DTV-330

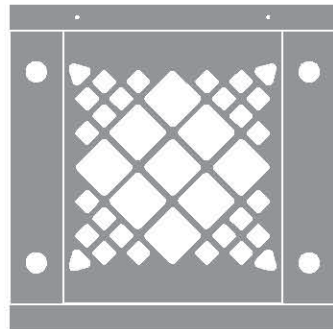

DTV-340

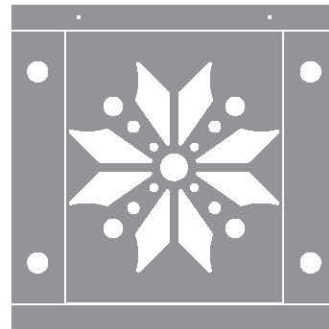

DTV-350

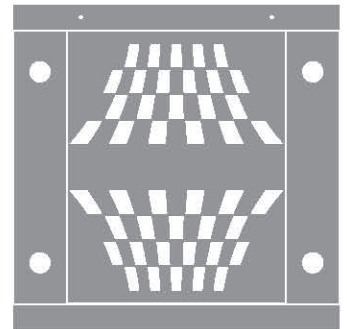

DTV-360

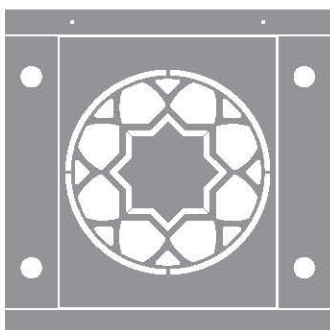

DTV-370

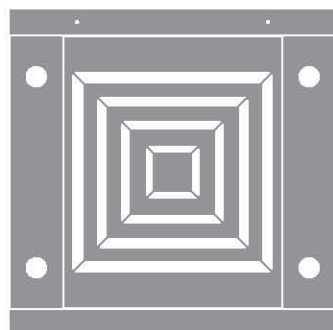

DTV-380

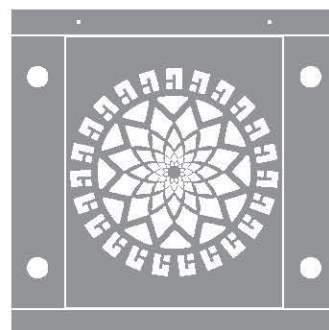

DTV-390

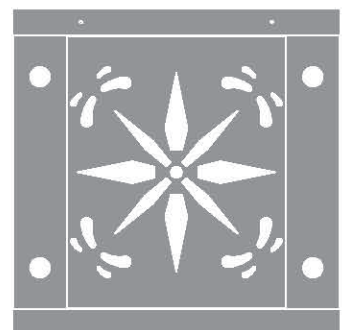

DTV-400



S-10



S-20



S-30



S-40

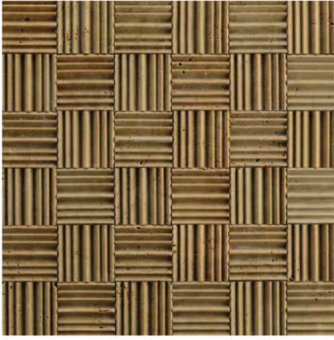

S-50



S-60



S-70



S-80



S-90



S-100



S-110



S-120

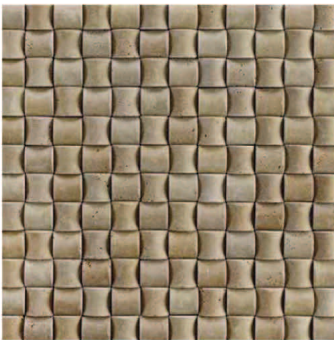

S-130



S-140



S-150



S-160



S-170

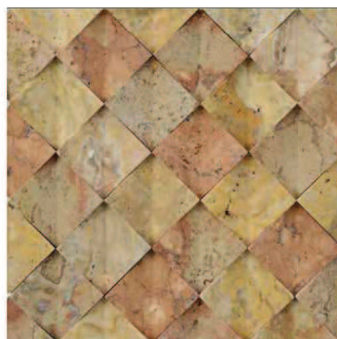

S-180



S-190



S-200



L SiSTEM

L system

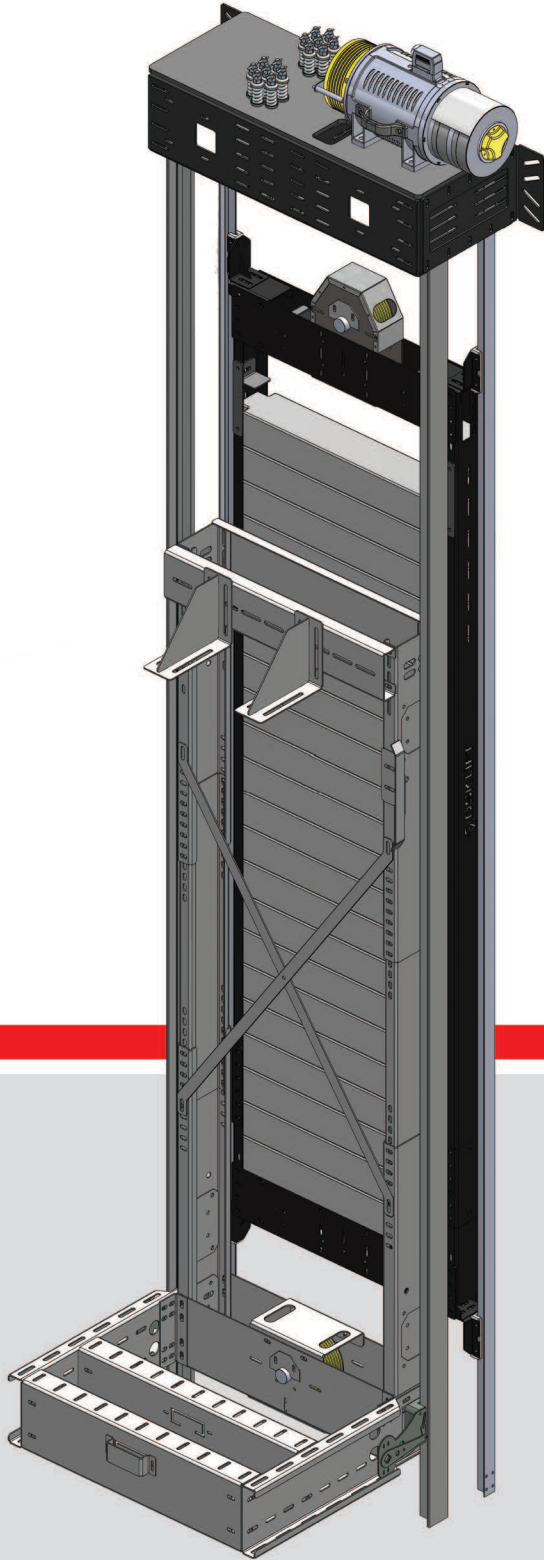

MRL SiSTEM I

Mrl system 1

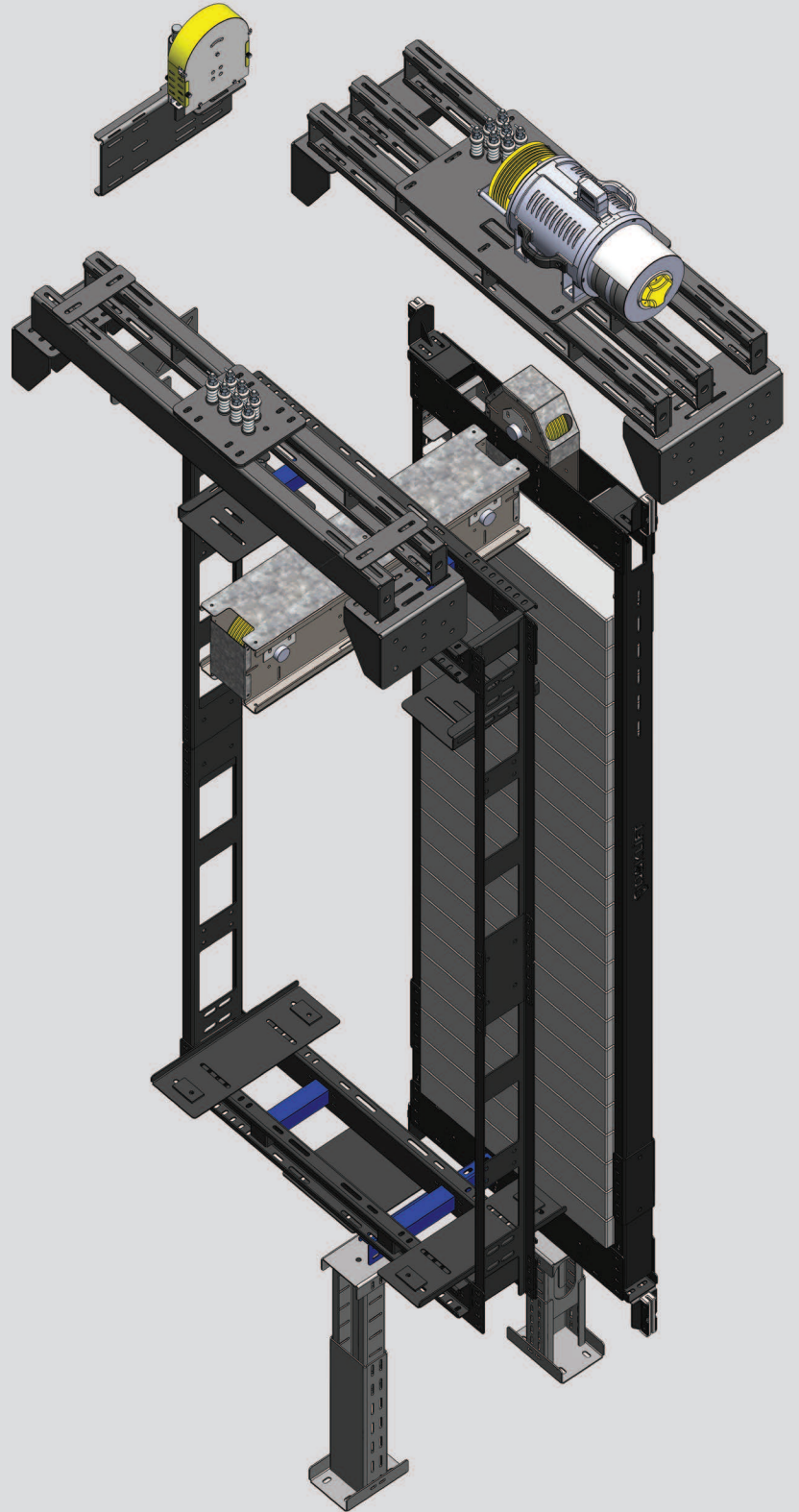

Süspansiyon ve Şaseler
Suspension and Chassis
التعليق والهيكل



MRL SiSTEM 2

Mrl system 2

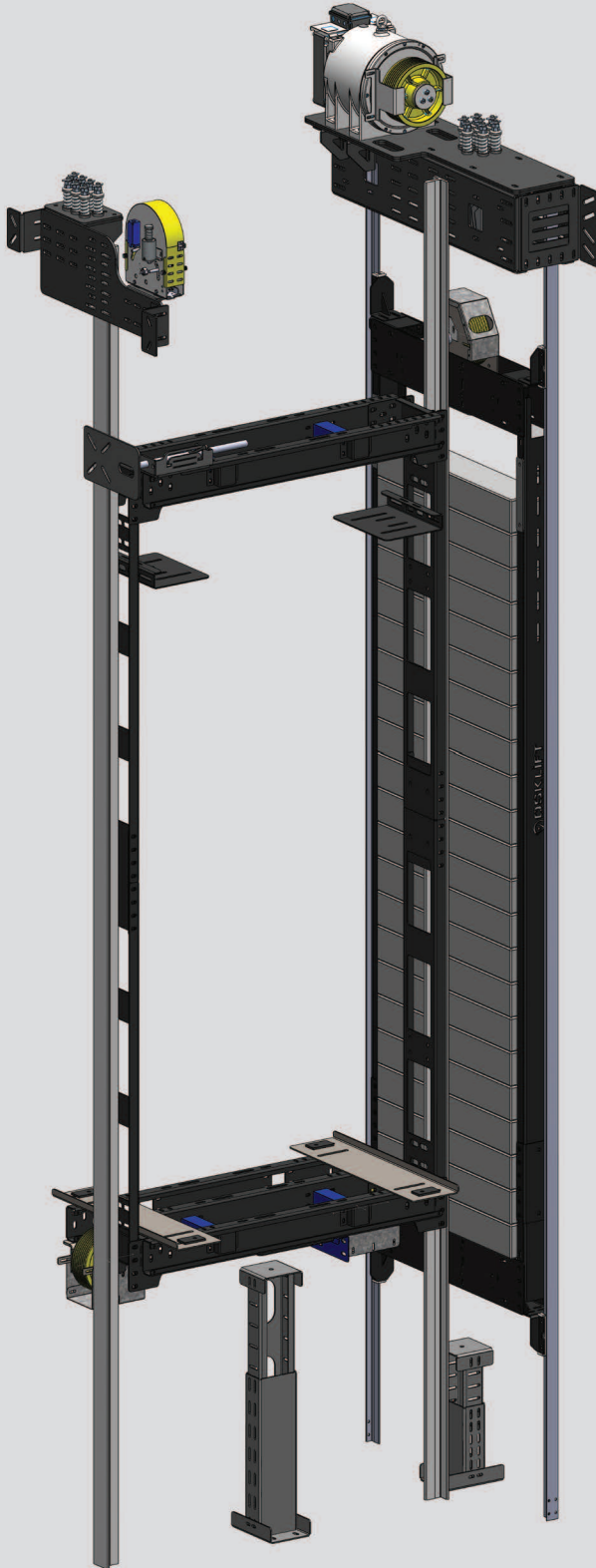

MR SiSTEM

Mr system

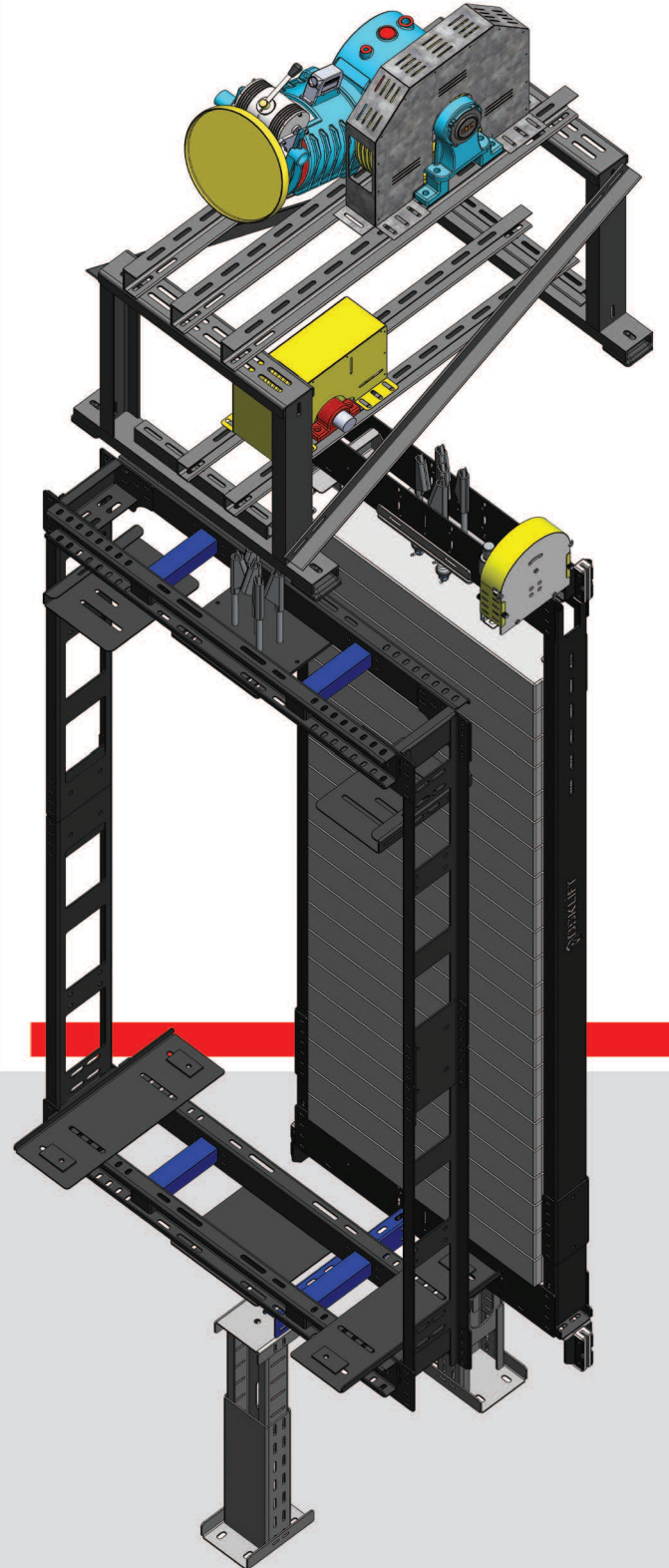

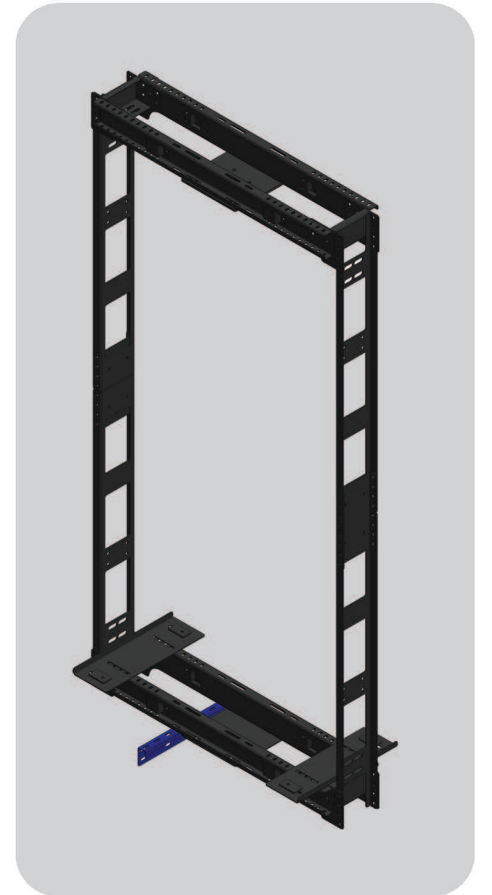
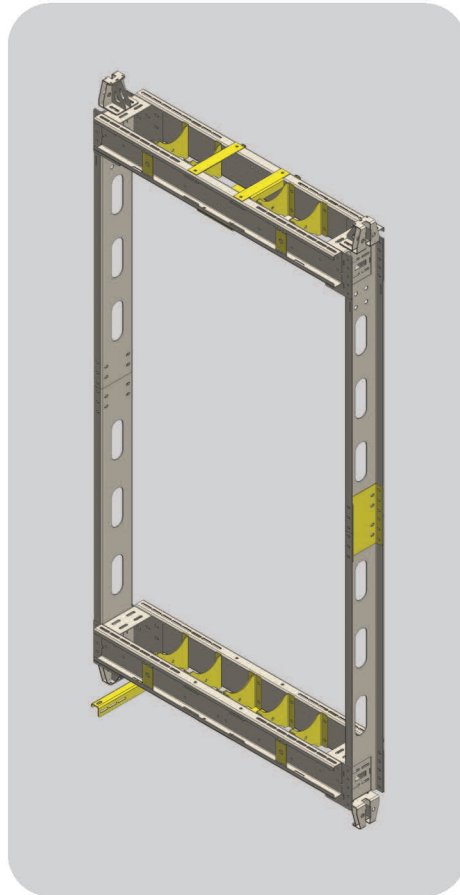
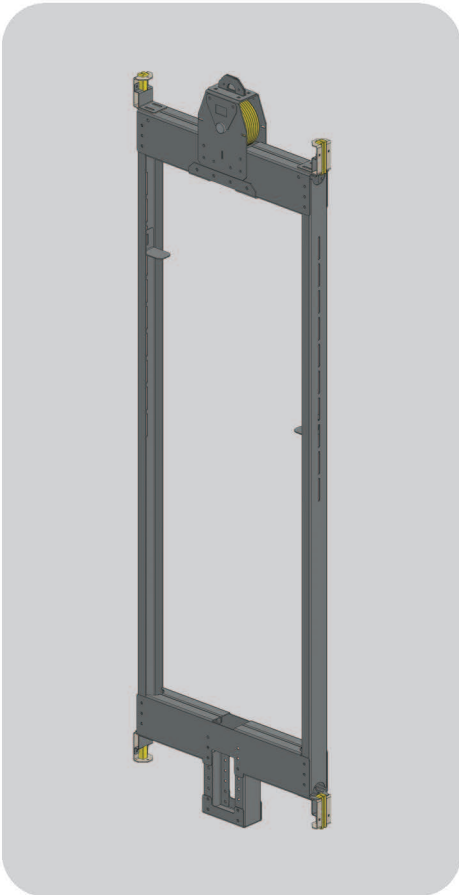
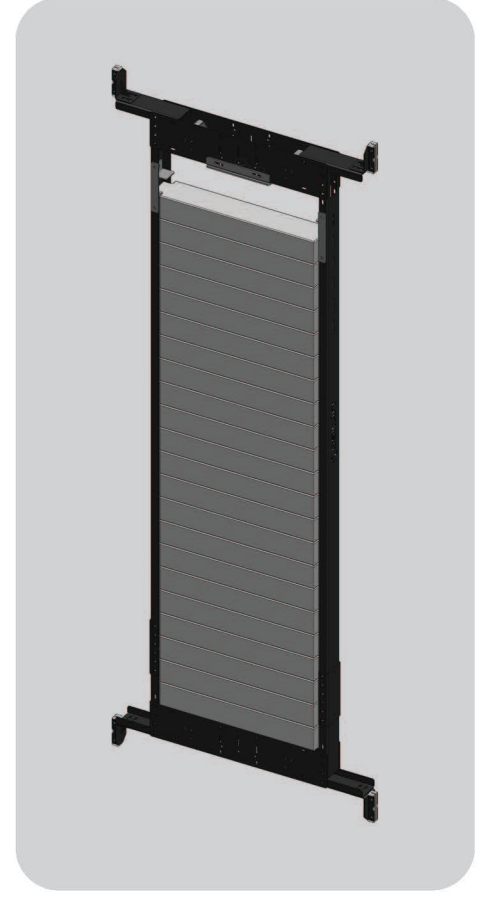

Süspansiyon ve Şaseler

Suspension and Chassis
التعليق والهيكل

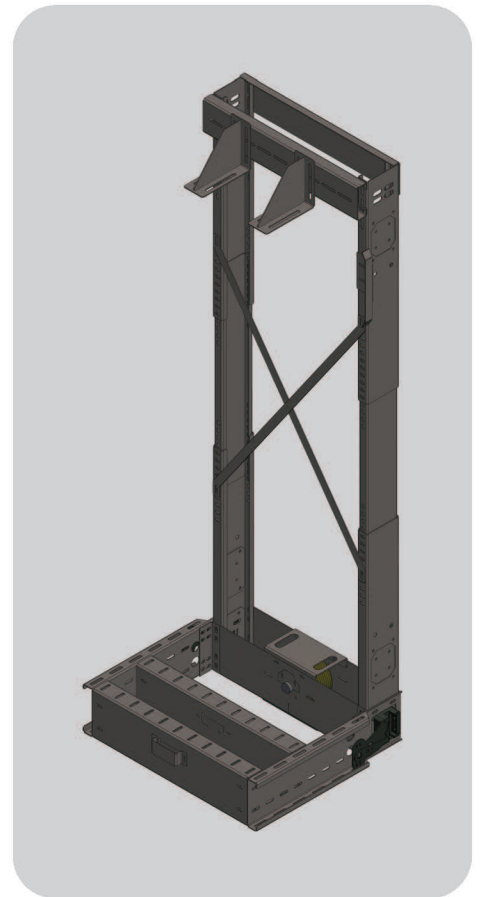
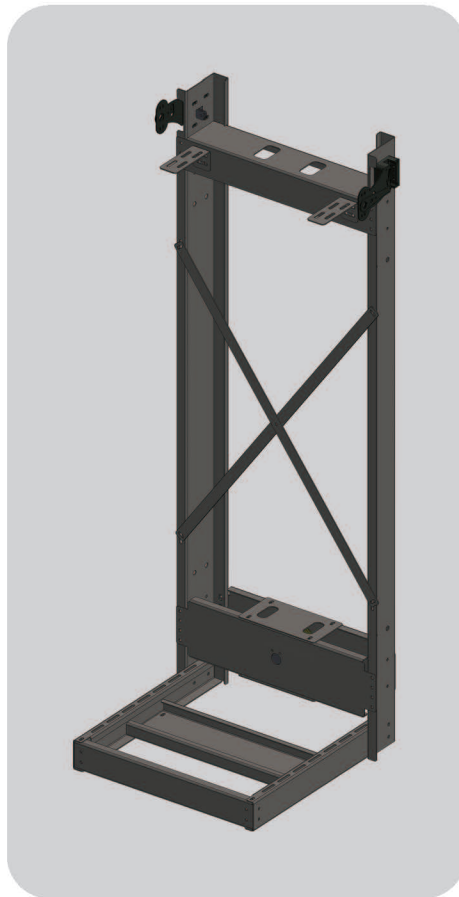
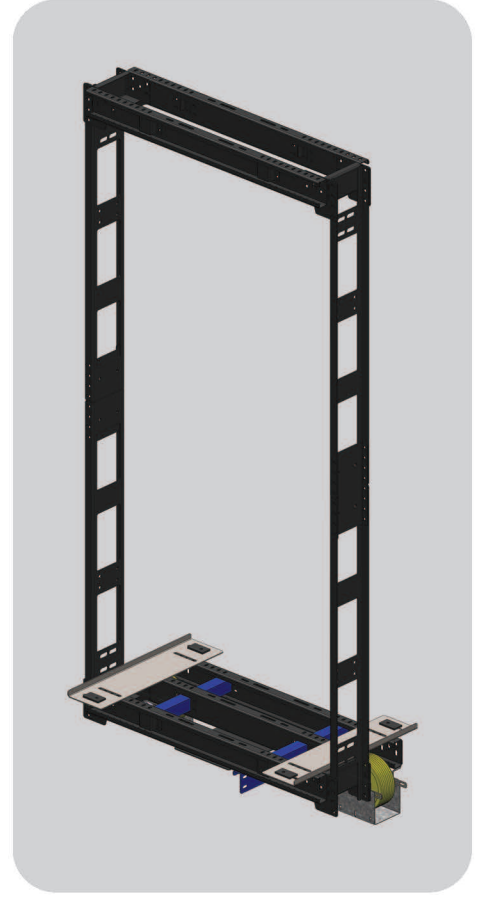
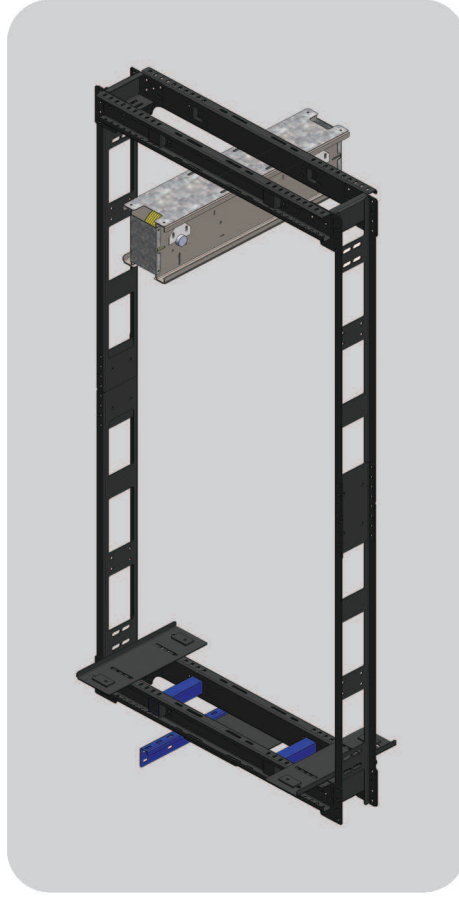
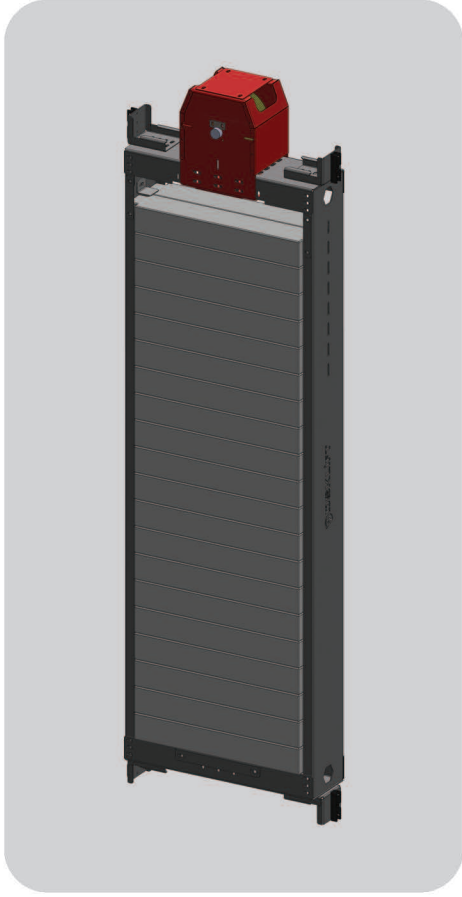

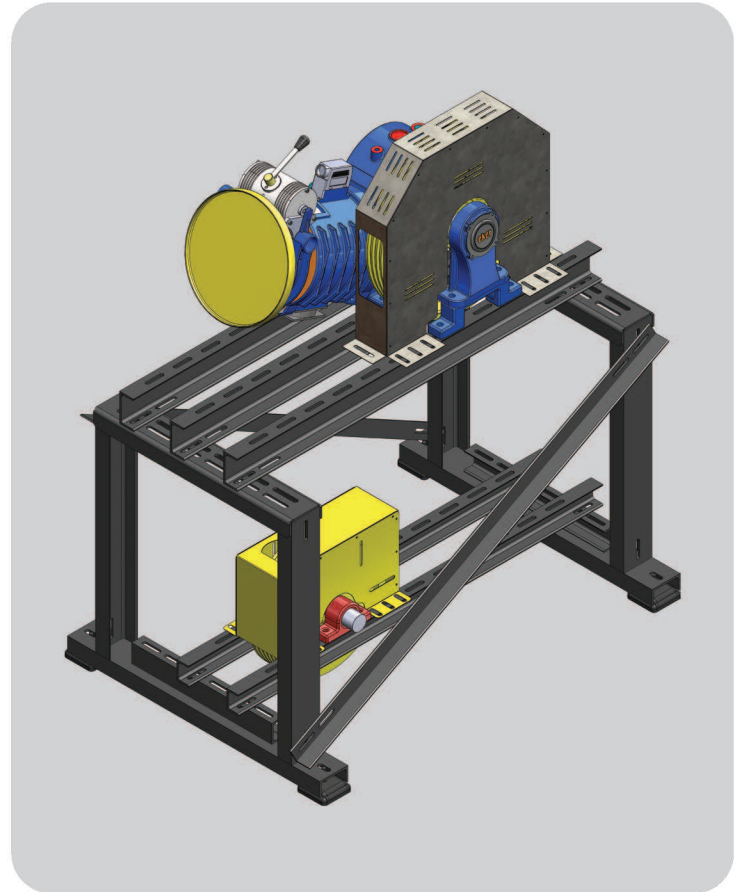
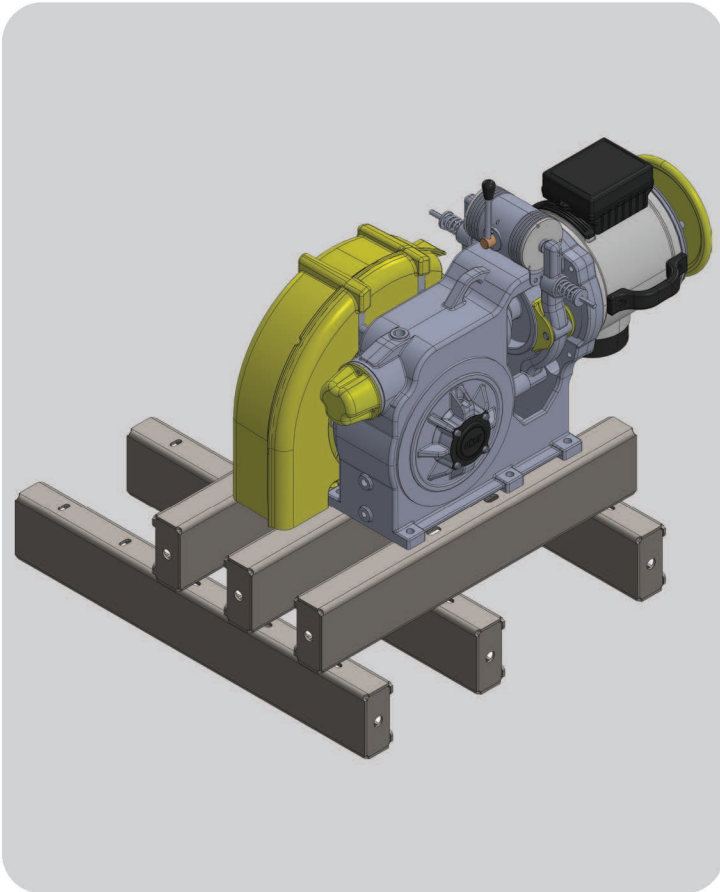
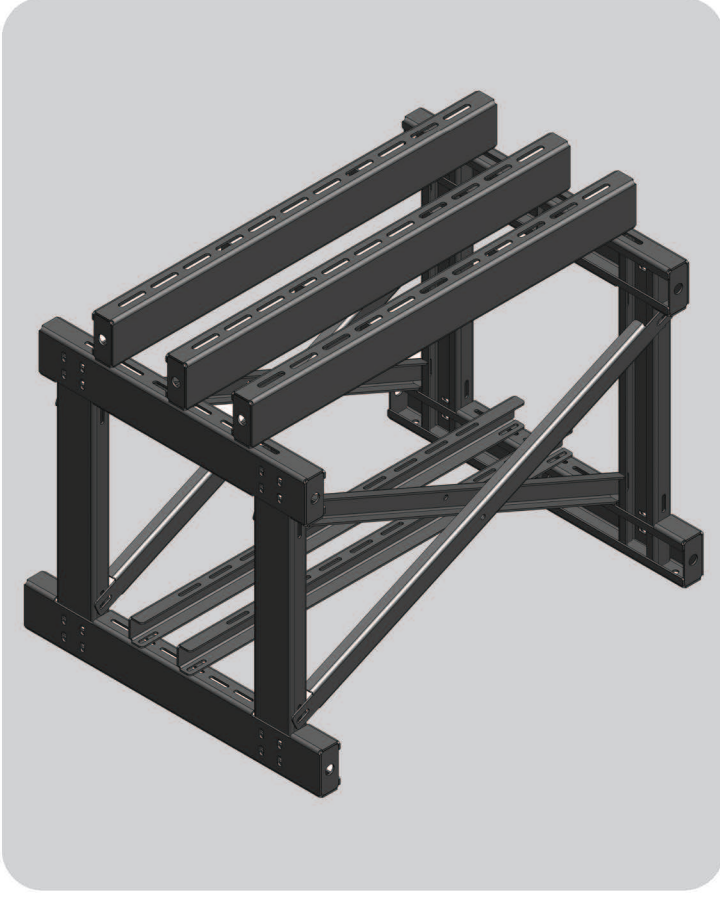

Makina Şaseleri

Machine Chassis
هيكل الآلة

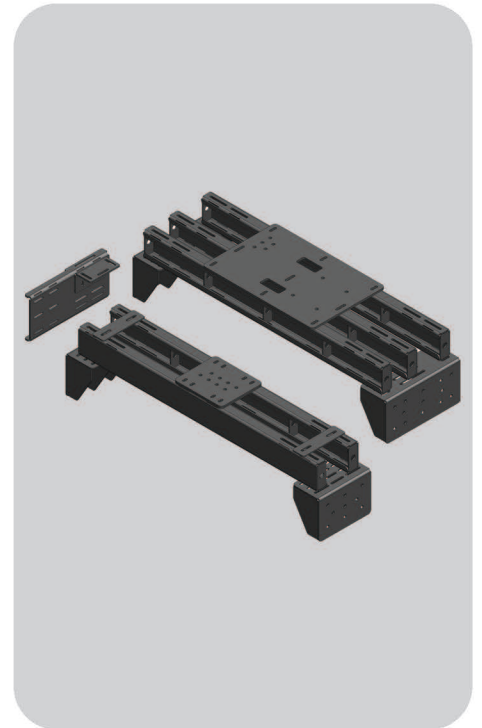
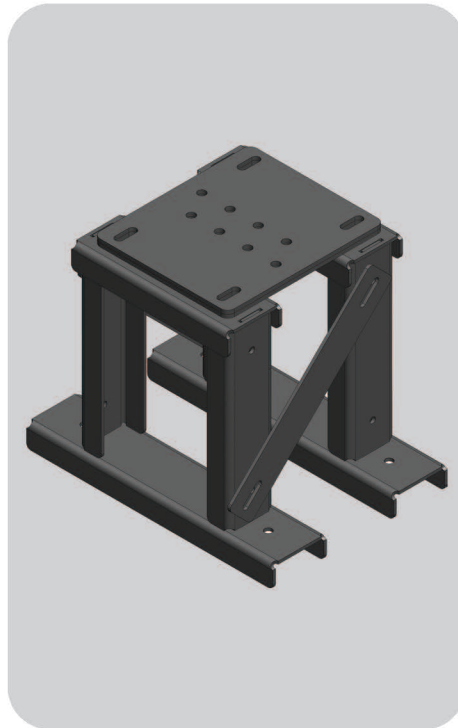
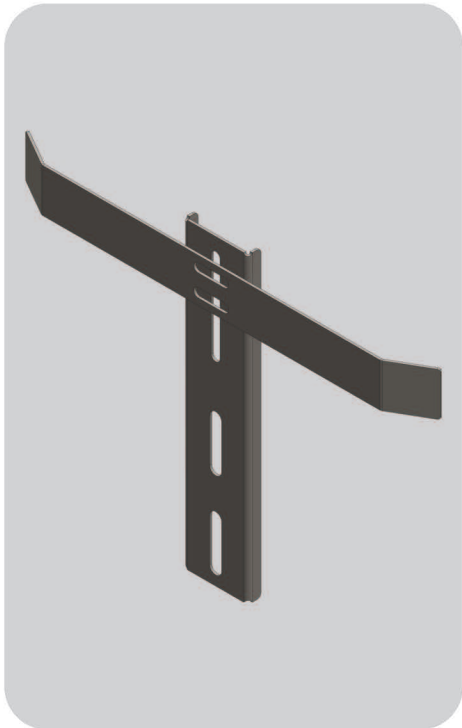
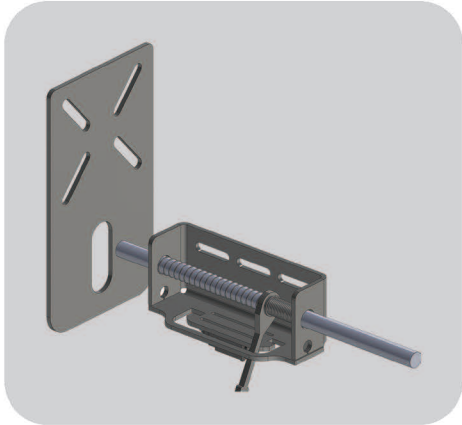
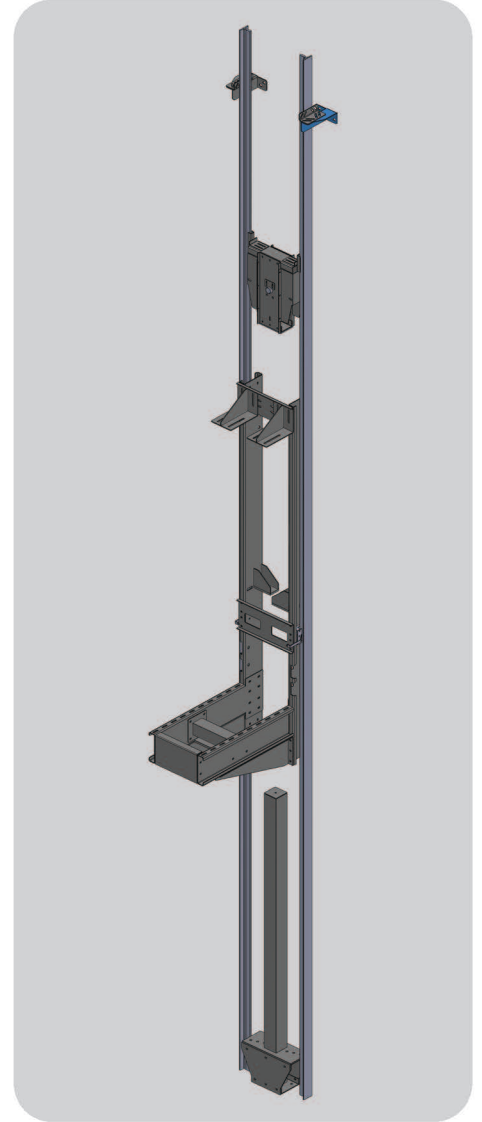
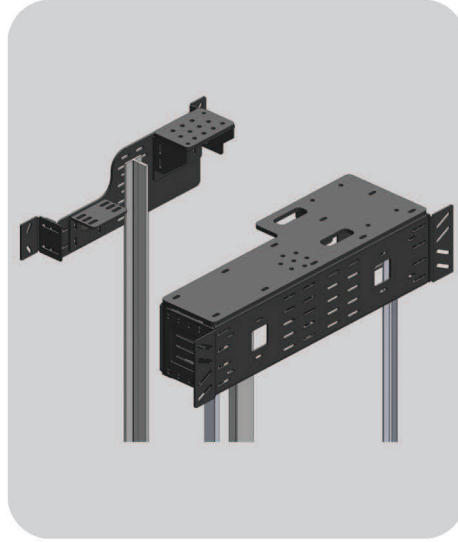

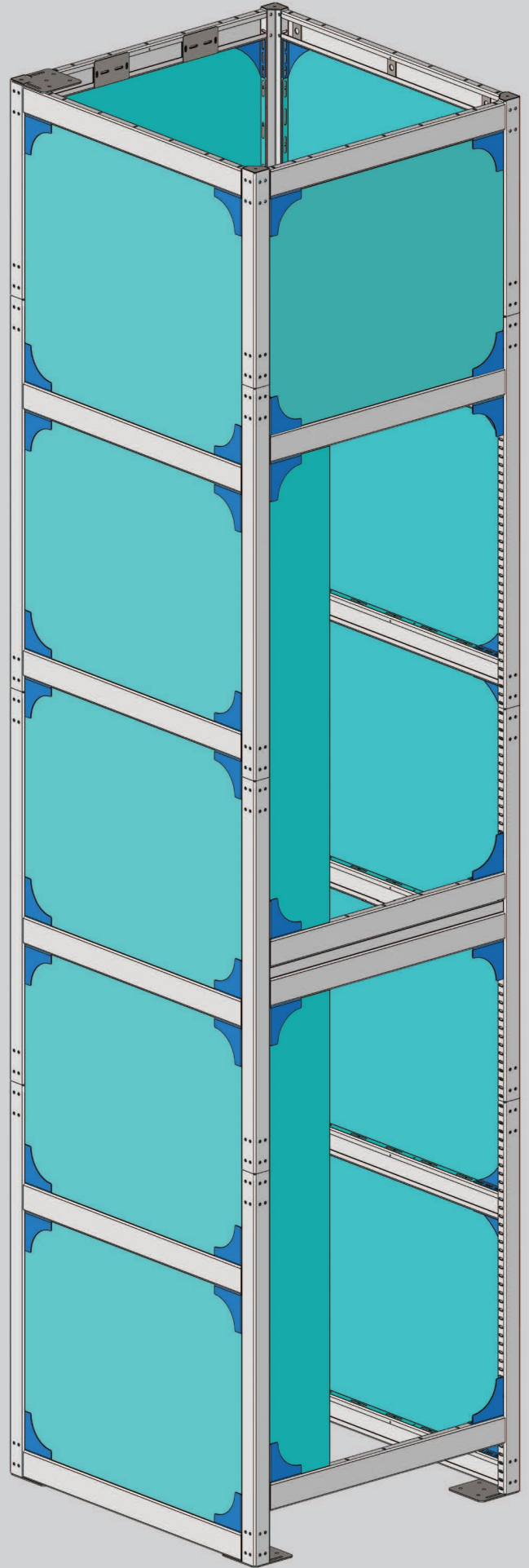
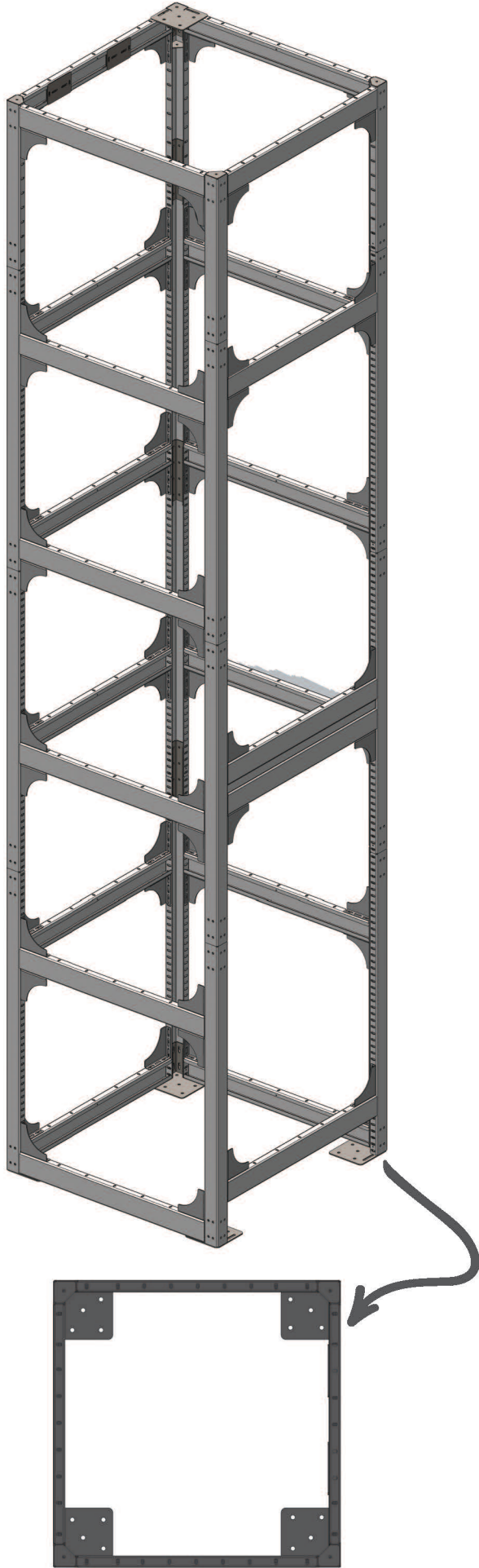



Asansör Kapıları
Elevator Doors



2 panel teleskopik
kat kapısı

Otomatik Kapılar

Automatic Door | الباب الأوتوماتيكي



2 panel teleskopik
kabin kapısı

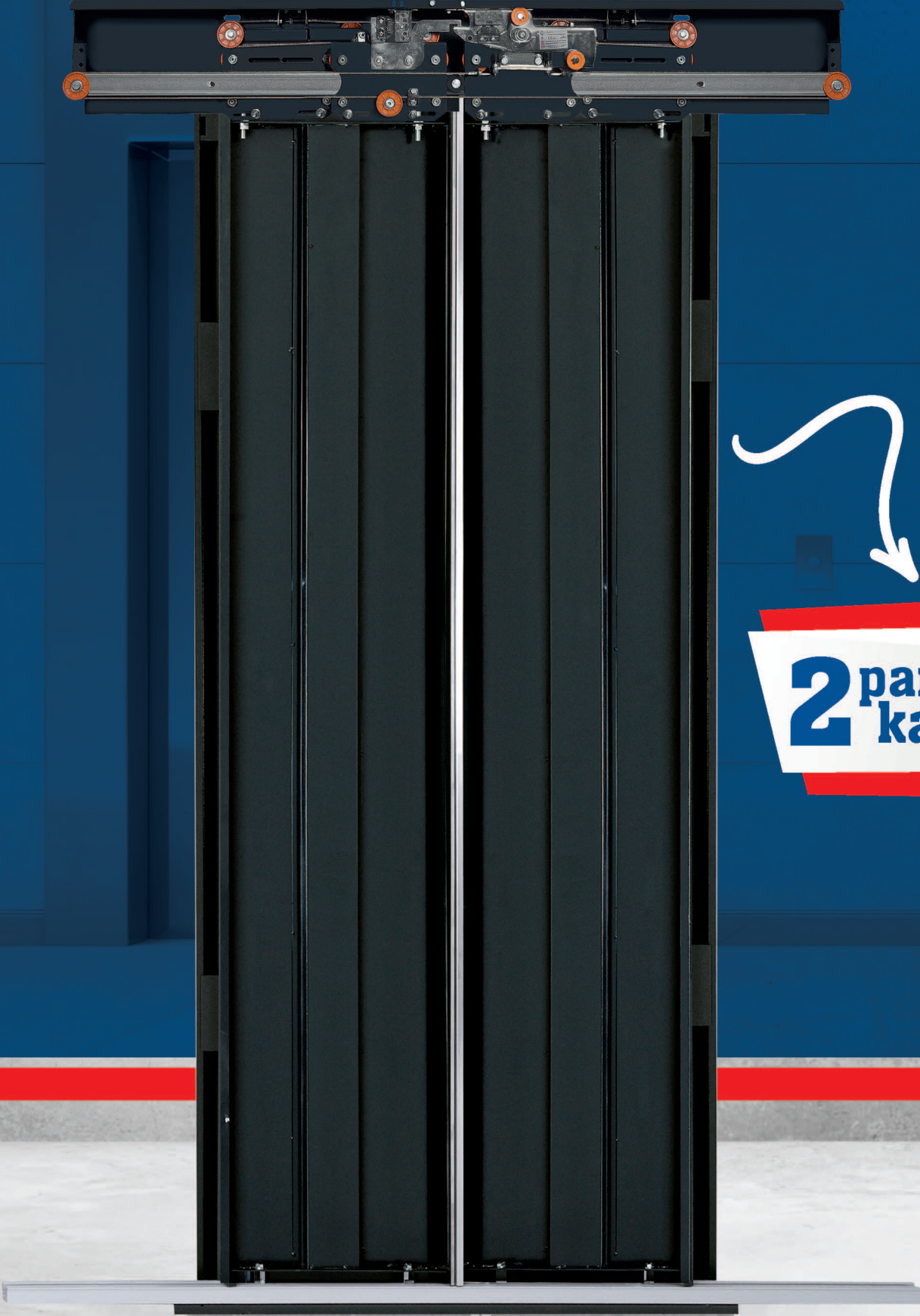

2 panel merkezi
kat kapısı

Otomatik Kapılar

Automatic Door | الباب الأوتوماتيكي



2 panel merkezi
kabin kapısı



2 panel merkezi
kat kapısı

Otomatik Kapılar

Automatic Door | الباب الأوتوماتيكي



2 panel merkezi
kabin kapısı



2 panel
iç güvenlik
kapısı

Kat Kapıları

Landing Door | باب الهبوط





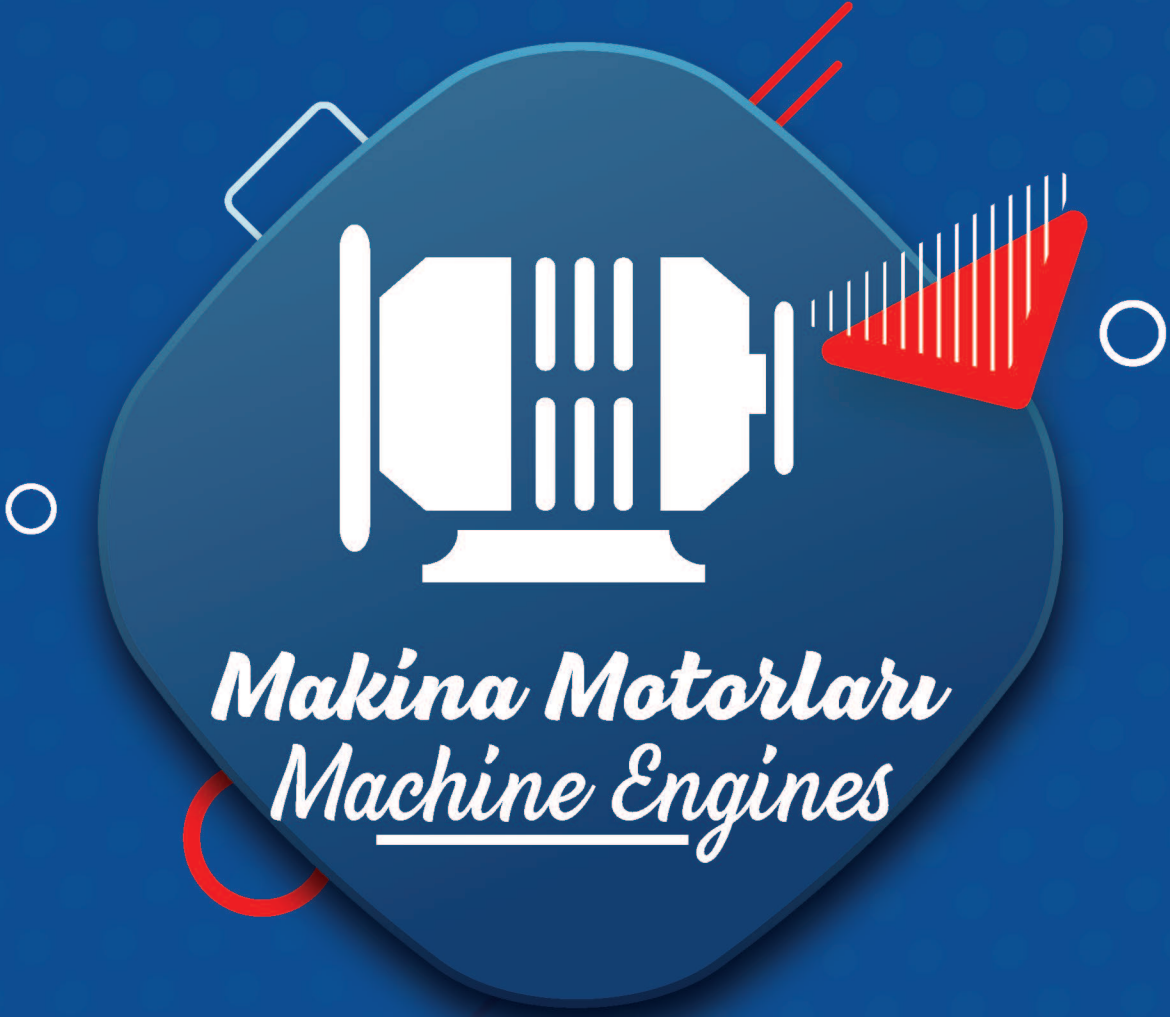



ELEGANCE ELITE 7,5



ELEGANCE PLUS 7,5



STRONG LITE 7,5

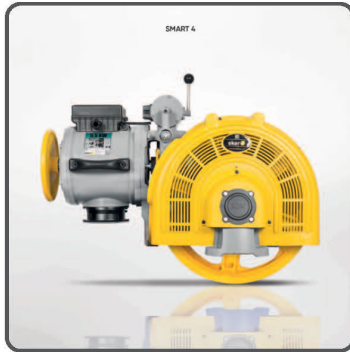

SMART 4



FORCE 22



STRONG PLUS 15



STRONG-9



QS-2



QS-3



QS-4



QS-6

Makine Motorları

Machine Motors | محرك الآلة



GEM-135B



GEM-140D



GEM-WTD-2

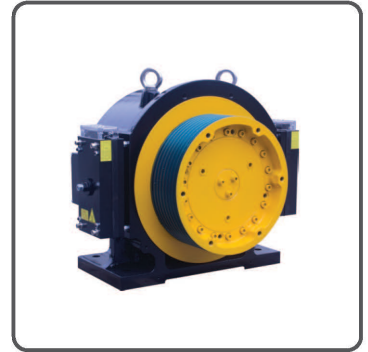

GEM-WTD-1



SASSI-TORO



SASSI-MODY



SASSI-S38



SASSI-G200-T1



SICOR-VS630



SICOR-S2V1250

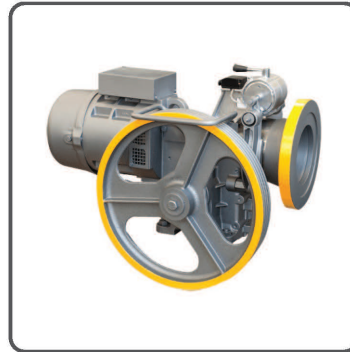

SICOR-SV480



SICOR-SMRL480



MONTANARI-M83

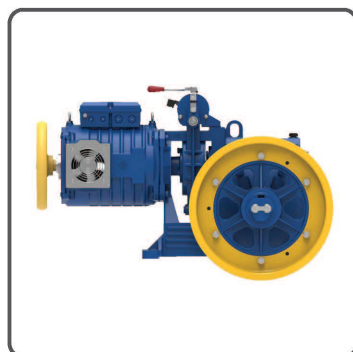

MONTANARI-M85

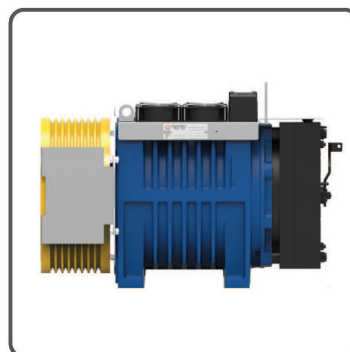

MONTANARI-MGV34 M



MONTANARI-MGV25S



VOLARE TRND TSK-2



AKAR



JUPA



AKAR



VOLTRON



NAGEL ÖZGEN

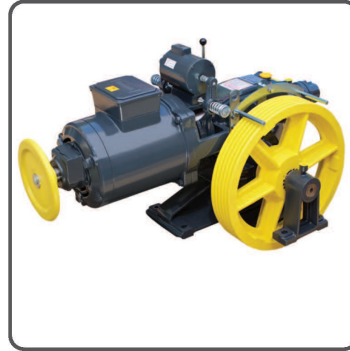

NAGEL KAYRA



NAGEL PARS



NAGEL



NAGEL

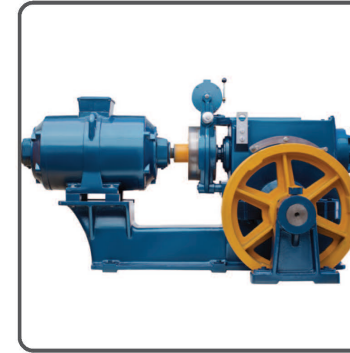

NAGEL KLASİK



WITTUR



CSAG-D



CSAG-K



CSAG-M



CSAG-T





Dişlisiz Pano
Gearless Control Panel
لوحة التحكم للمحركات بدون تروس

Dişlilili Pano
Geared Control Panel
لوحة التحكم مع غرفة المحرك

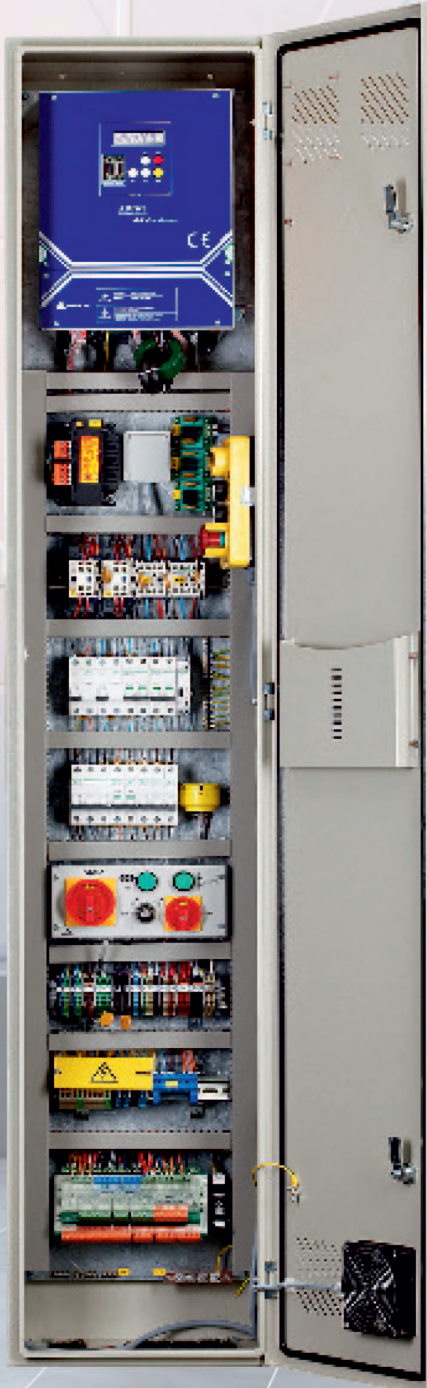

Revizyon Kutusu
Revision Box
صندوق المراجعة



Kumanda Panoları

Control Panels | لوحات التحكم



EI Terminali | AREM Terminal



ARLINE Uzaktan İzleme, Alarm ve İnterkom Sistemi | ARLINE System

Dışsız Pano Gearless Control Panel

لوحة التحكم للمحركات بدون تروس



Dışlılı Pano Geared Control Panel

لوحة التحكم مع غرفة المحرك



Revizyon Kutusu Revision Box

صندوق المراجعة



Dişlisiz Pano
Gearless Control Panel
لوحة التحكم للمحركات بدون تروس



Dişli Pano
Geared Control Panel
لوحة التحكم مع غرفة المحرك



Revizyon Kutusu
Revision Box
صندوق المراجعة



HEDEFSAN®
ASANSÖR KONTROL SİSTEMLERİ

Dışısız Pano
Gearless Control Panel
لوحة التحكم للمحركات بدون تروس

Dışılı Pano
Geared Control Panel
لوحة التحكم مع غرفة المحرك

Revizyon Kutusu
Revision Box
صندوق المراجعة





Butonlar

Buttons | أزرار





ASB 2500-B9 ASB 7000-B2 ASB 5000-B1 ASB 7000-B1 ASB 6000-B1 ASB 4000-B6 ASB 1000-B1 ASB 2000-B3 ASB 2000-B1 ASB 6100-B4 ASB 800-B3



AVANTGARDE ASB 420D-S3 ASB 420D-S5 ASB 130-S1 ASB 130-S4 ASB 420 D-S2 ASB 425-MONŞARJ

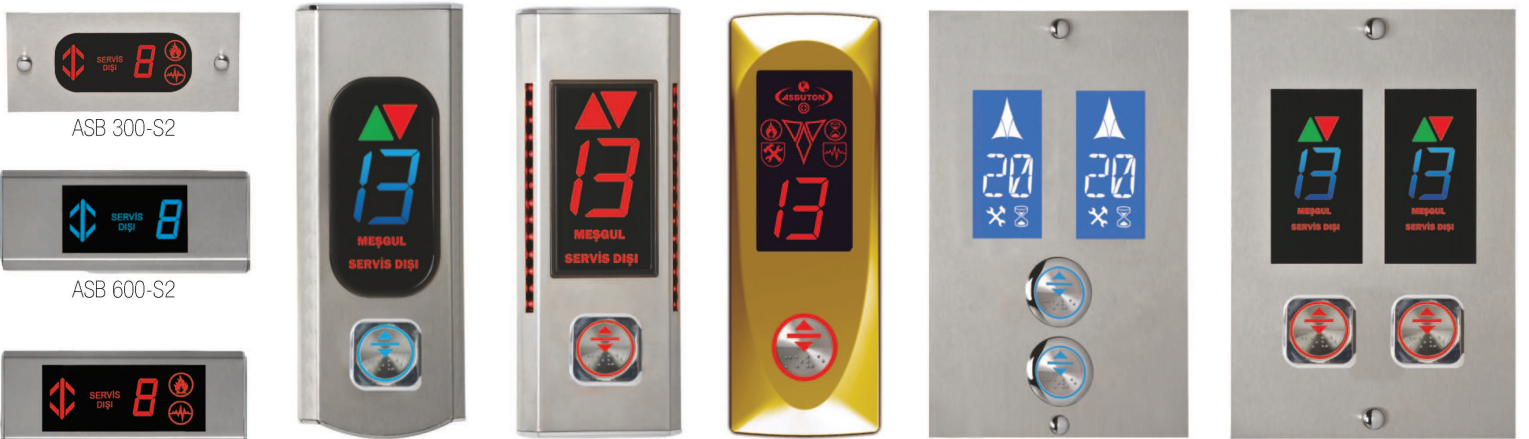

ASB 300-S2

ASB 600-S2

ASB 600-S1

ASB 420 Y-S3

ASB 450-S1

ELEGANCE-S6

ASB 200-S3

ASB 200-S2



AHTAPOT YANDAN AĞIRLIK SİSTEMİ 1 / AHP-01-F
OCTOPUS SIDE COUNTER WEIGHT BRACKET SYSTEM 1

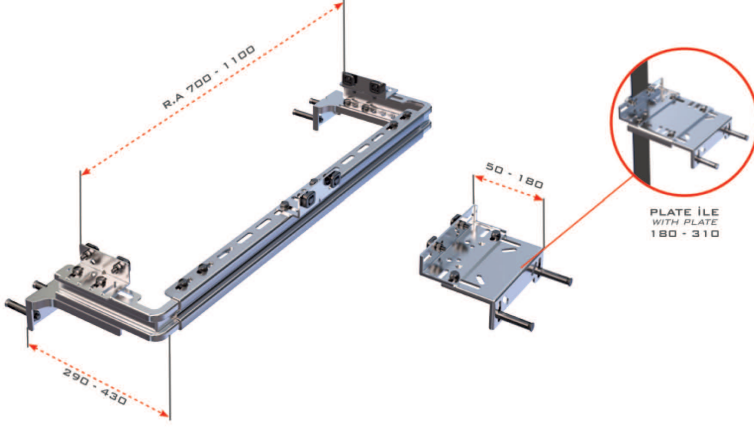

AHTAPOT ARKA AĞIRLIK SİSTEMİ 1 / AHP-03-F
OCTOPUS COUNTER WEIGHT BRACKET SYSTEM 1

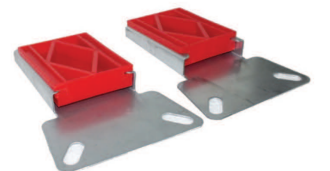
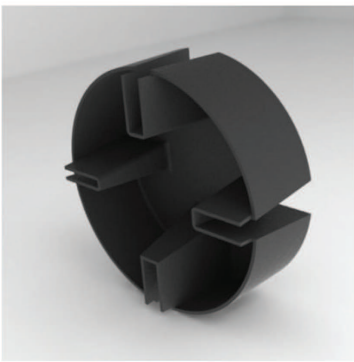
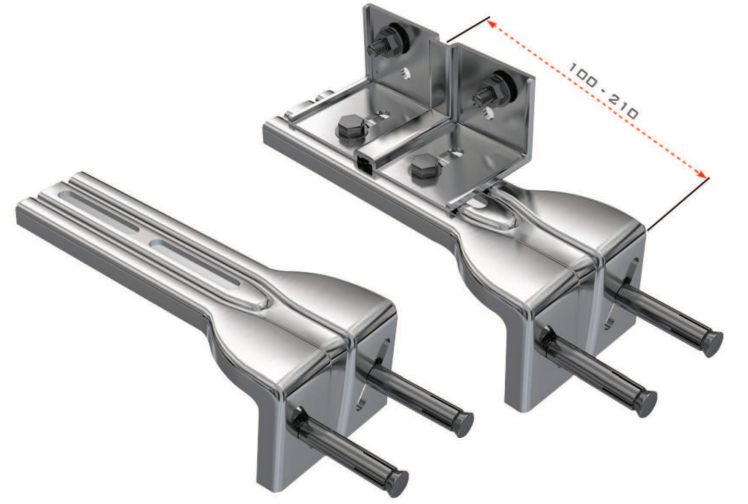
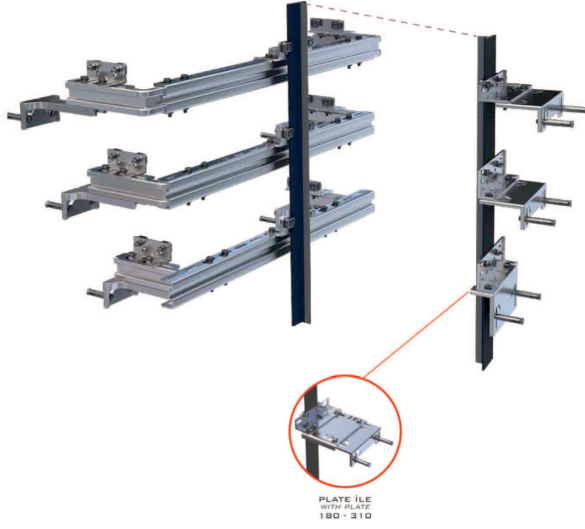
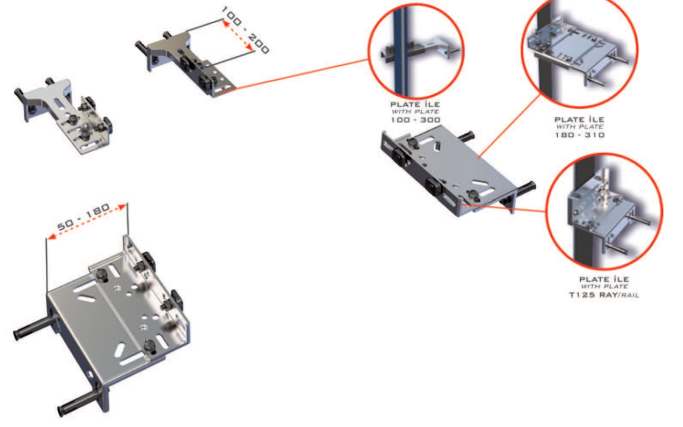

Asansör Ekipmanı

Elevator Equipments | معدات المصاعد

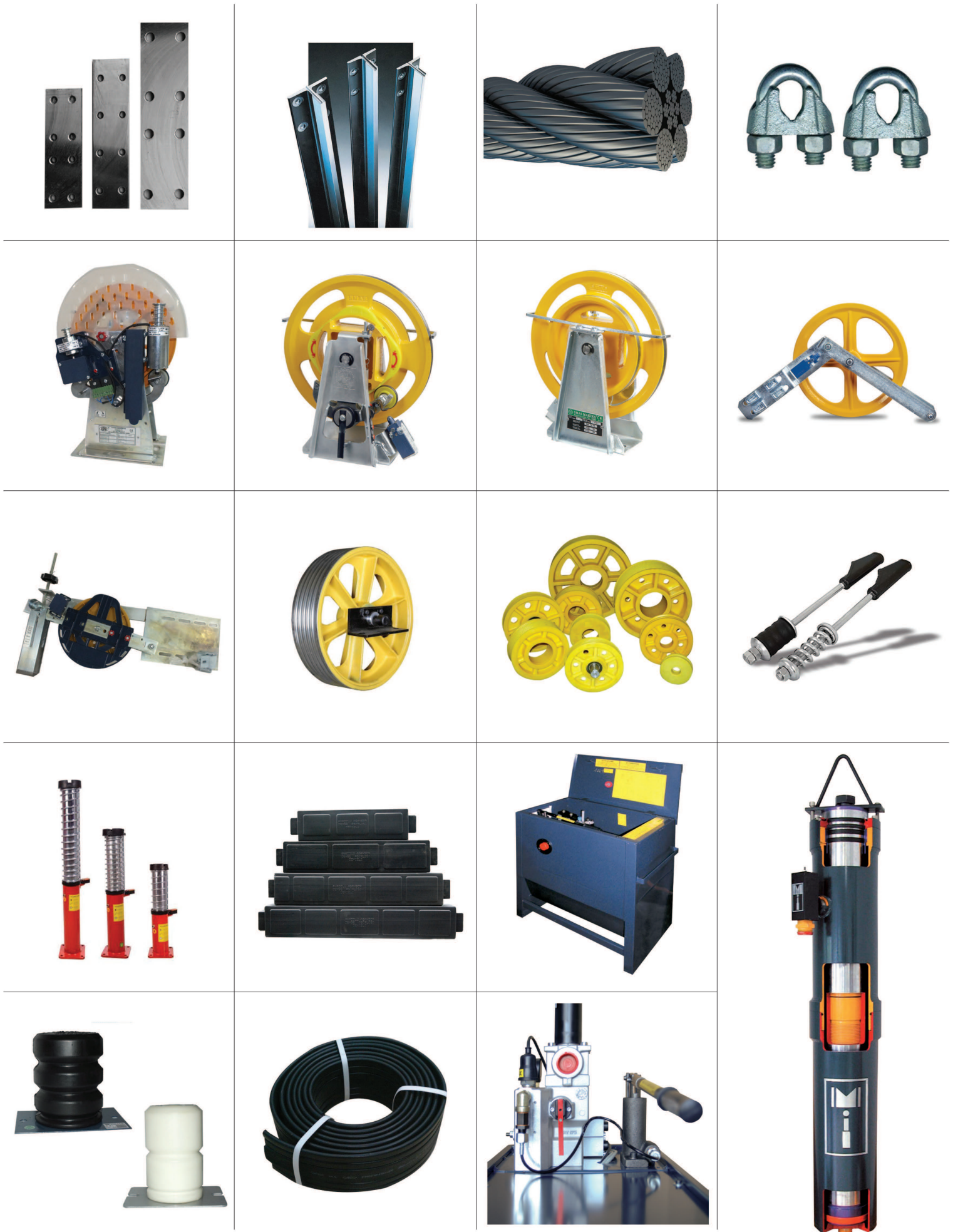

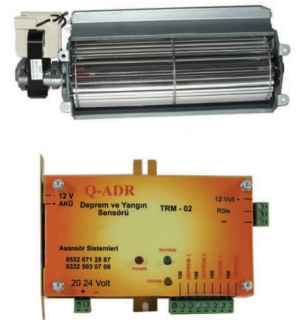

Gerekli Bilgiler

Necessary Information
معلومات ضرورية



Kuyu Ölçü Değerleri | Shaft Dimensions | قياسات الحجرة

ASANSÖR KAPASİTESİNE BAĞLI KUYU ÖLÇÜLERİ (MİNİMUM DEĞERLER) Based on capacity of cabin , dimensions of shafts (Minimum Values) قياسات الحجرة المصاعد			
KAPASİTE (kişi) Capacity (Per) شخص	KAPASİTE (KG) CAPACITY(KG) الوزن(KG)	KUYU GENİŞLİĞİ (CM) WIDHT OF SHAFT(CM) حجرة العرض (CM)	KUYU DERİNLİĞİ (CM) DEPTH OF SHAFT(CM) عمق الحجرة (CM)
4	300	150	150
5	400	160	160
6	450	165	165
7	525	170	170
8	630	180	170
13	1000	200	240
17	1275	210	280
21	1600	240	300

ASANSÖR KAPASİTESİNE BAĞLI KABİN ALANLARI Based on capacity of elevators, dimensions of cabins قياسات كابین المصاعد					
KAPASİTE (kişi) CAPACITY (Per) شخص	KAPASİTE (KG) CAPACITY (KG) الوزن(KG)	KABİN ALANLARI (M²) DIMENSIONS OF CABINS (M²) منطقة الكابین (M²)	KAPASİTE (kişi) CAPACITY (Per) شخص	KAPASİTE (KG) CAPACITY (KG) الوزن(KG)	KABİN ALANLARI (M²) DIMENSIONS OF CABINS (M²) منطقة الكابین (M²)
1	100	0,28-0,38	11	825	1,87-2,05
2	180	0,49-0,58	12	900	2,01-2,20
3	225	0,60-0,70	13	1000	2,15-2,40
4	300	0,79-0,90	14	1050	2,29-2,50
5	375	0,98-1,10	15	1125	2,43-2,65
5	400	1,10-1,17	16	1200	2,57-2,80
6	450	1,17-1,30	17	1275	2,71-2,95
7	525	1,31-1,45	18	1350	2,85-3,10
8	600	1,45-1,60	19	1425	2,99-3,25
8	630	1,45-1,66	20	1500	3,13-3,40
9	675	1,59-1,75	21	1600	3,56
10	750	1,73-1,90	26	2000	4,20
10	800	1,73-2,00	33	2500	5,00

Referans: TS 10922 (EN81-1), EN81-2

TR 2500 kg üzerinde her 100 kg için 0,16 m² alan ilave edilir.
20 kişi üzerinde insan sayısı için 0,115 m² ilave edilir.

EN Over 2500 kg, for each 100 kg is added 0,16 m²
Over 20 persons, for each person is added 0,115 m²

AR 0,16 m² ۲۵۰۰ کج ۱۰۰ کج مقابیل کل
0,115 m² ۲۰ شخصاً لاکثر من

AZ^{ye} Aşansör Ekipmanları



Büyükkayacık Mh. 2. Organize Sanayi Bölgesi
Işıktepe Sk. No:15 Selçuklu / KONYA / TÜRKİYE

T:+90 332 341 2 444 | F:+90 332 341 2 555
www.duseko.com | duseko@duseko.com

